

Flinders University
Australian Industrial
Transformation
Institute

From ship to shore

Reducing the barriers to collaborative robot
uptake in shipbuilding and manufacturing
through human factors



Sara Howard, Arvind Rajagopalan, Kosta Manning, Valerie
O'Keeffe, Ann-Louise Hordacre and John Spoehr

Australian Industrial Transformation Institute

May 2021



From ship to shore

**Reducing the barriers to collaborative robot
uptake in shipbuilding and manufacturing
through human factors**

Australian Industrial Transformation Institute

College of Business, Government and Law
Flinders University of South Australia

1284 South Road
Clovelly Park
South Australia 5042

www.flinders.edu.au/aiti

URL:<http://www.flinders.edu.au/aiti/>

CAT: AITI202105

Suggested citation:

Howard, S., Rajagopalan, A, Manning, K., O’Keeffe, V., Hordacre, A.L. & Spoehr, J (2021). *From ship to shore. Reducing the barriers to collaborative robot uptake in shipbuilding and manufacturing through human factors*. Adelaide: Australian Industrial Transformation Institute, Flinders University of South Australia.

This report is based on work funded by the Department of Industry, Science Energy and Resources (Innovative Manufacturing CRC) in collaboration with BAE Systems Maritime Australia.

The Australian Industrial Transformation Institute (AITI) has taken care to ensure the material presented in this report is accurate and correct. However, AITI does not guarantee and accepts no legal liability or responsibility connected to the use or interpretation of data or material contained in this report.

Key findings

CONTEXT

Human factors and ergonomics (HFE) explores the interaction between humans, their work and the environment in which it takes place (including the tools and equipment involved). HFE aims to deliver productivity and wellbeing gains through deep understanding of the experience and capabilities of humans.

Collaborative robots (cobots) are speed and force limited industrial robotic arms that are designed with reduced pinch-points, smooth joint-shells and in-built safety sensors. Among their intended benefits are increased productivity, improved product quality and improved employee ergonomics.

A low complexity **glue dispensing task** performed in a laboratory environment was conducted to compare manual (person) dispensing efforts with cobot-assisted dispensing (see images below) which involved users teaching the cobot the glue path via hand-guiding (i.e. repeated measures trial design). In addition to task performance measures, trial participants provided a range of feedback relating to the task as well as cobots and their work environment more broadly.

The manual method



The cobot method

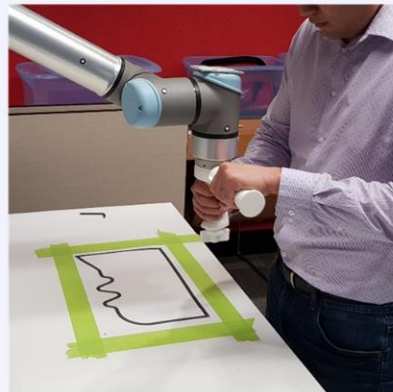

Source: AITI Photo Stock 2021

The results and insights provided here are based on the experience of a total of 19 users (including 1 female) from the **shipyard and manufacturing small and medium-sized enterprises (SMEs) in Adelaide, South Australia** (some apprentices were included). Ages ranged from 18 to 61 years.

Compared to the manual version of the dispensing task, the cobot-assisted method resulted in:

- Significantly reduced workload for users
 - The latter was perceived to be less physically demanding, less temporally demanding (slower pace), resulted in greater success/task performance (i.e. accuracy/quality of glue bead), less effort to achieve the level of performance and evoked less stress or frustration.
- Significantly reduced musculoskeletal risk
 - The cobot method achieved a low-risk score indicating that change may be needed to the set-up in the future whereas the manual task was of medium risk indicating that change is required soon. The manual method required participants to use an electric caulking gun which was heavy and long with an unbalanced centre of gravity imposing awkward postures.

- Significantly reduced time to dispense the glue for the task
 - The cobot dispensed the glue in almost half the number of seconds required by the human.
- Significantly greater glue consumption
 - For half of users, the cobot consumed 39 grams or more of glue when dispensing for the task. For the manual method, half of participants used 22 grams or more of glue when dispensing onto the path.
 - This result is likely a product of the design of the in-house cobot dispensing unit and would be refined prior to industrial implementation, noting the optimum amount of glue for task was not determined as part of the task protocol.
- No significant differences were detected in the quality of the glue bead (measured by the total number of errors) between the manual and cobot-assisted dispensing methods.
 - However, the nature of errors did vary and suggest that the cobot did a better job of ensuring sufficient glue coverage of the glue path (i.e. almost no 'too thin' or 'no bead' errors). It would suit application where this is of particular importance/concern.
 - Based on broad observation of the glue beads by both researchers and participants, the glue bead deposited by the cobot was perceived to have reduced variability (fewer errors, especially with regards to the height of the bead) compared to the human effort.
 - Height of the glue bead (3D profiling) is a desirable evaluation component which could provide further information regarding quality parameters for each method.
 - The evaluation of the glue bead does not capture the severity of the different types of errors and more broadly, the importance of each error type is likely to vary depending on the context/product involved.

The trial emphasises two key HFE principles, namely:

- **Performance and design are interdependent;** poor caulking gun usability, surface friction and constraints of the laboratory set-up (e.g. lack of adaptability in and poor accessibility to work surfaces) impaired user experience and performance, particularly in the manual glue dispensing task. In an industrial environment, controls would be introduced to mitigate such consequences.
- **Employee motivation and satisfaction is linked to good job design;** completing this low complexity dispensing task for extended periods, whether manually or with the assistance of a cobot, does not constitute good job design. A person's job should entail skill variety, task identity, task significance, autonomy and job feedback. Therefore, user ratings and experience of any component of their job needs to be interpreted relative to/within the context of all their roles and responsibilities to ensure good job design and engaged employees.

Participants rated the usability of the cobot favourably with nearly all participants (90%) preferring this method over manual dispensing. Regarding future uptake, end-users agreed that cobots are valuable when applied to the 'right' job. This relies on human understanding of both human and robotic characteristics, vision of what is possible (e.g. degree of human-robot collaboration) and sound decision-making to ensure that jobs of the future are well-designed and thus provide workers with job satisfaction and wellbeing.



To conclude, the **main drivers** for end-users to accept and adopt cobots include:

- Appreciation that they are good for business (e.g. competitive advantage, sustainability)
- They provide a sense of personal accomplishment due to the associated learning and expansion of skills and
- They provide improved user safety and productivity.

The **main barriers** end-users perceive inhibiting the acceptance and adoption of cobots in industry include:

- Resources (cost)
 - Although decreasing in cost over recent years, the upfront costs associated with the procurement of a cobot (e.g. AU\$35,000+) can be prohibitive for many businesses.
- Limitation of applications
 - Users were unsure how adaptable cobots would be working with specific materials and how consistent performance quality would be. Users were hesitant about considering cobots for any tasks which were not repetitive, of low complexity and completed in a fixed location.
- Industrialised work environment
 - Inadequate lighting, extreme temperatures, unstable surfaces, loud noise and space constraints are common job site conditions. To be used widely, cobots would need to accommodate and demonstrate their effectiveness in these contexts.
- Support for personnel
 - Some users were somewhat sceptical about the claims that cobots are fast to set up and simple to use. Quality (appropriateness) of instructions provided to operators and access to training and support, especially during initial learning are essential to successful implementation.
- Change management
 - Business leaders need to take a people-centric approach when introducing any change. This requires the resources and competencies to recognise emotions (e.g. fear of unknown), share information and communicate with employees and stakeholders regularly.

Recommendations

To accelerate the uptake of cobots in the shipyard and industry more broadly, the authors make the following 'adoption accelerator' recommendations:

Resources (cost)

- The development of HFE business cases when considering the implementation of cobot technology. These business cases can detail the impact/cost of inaction (i.e. what are the costs to the business when employees are engaged in 'dull, dirty and dangerous' work?) and should consider savings related to the prevention or minimisation of injury, absenteeism and disengagement in addition to any productivity gains.
- Where appropriate, technology trials can be used help determine the value and type of investment appropriate for the business.

Limitation of applications

- Researchers and industry should increasingly collaborate to produce case studies which demonstrate the variety of possible cobot applications, focusing on degree of collaboration and task complexity. Process tasks which may hold most prominence for defence industry end-users include welding and polishing.

Industrialised work environment

- Workplace design and cobotics options need to be fit-for-purpose:
 - The pedestal or portable surface on which a collaborative robot is fixed needs to be easily adjustable so that the worktop can be set in the right position (i.e. levelled) at all times. Built-in spirit levels to all cobot-bases/pedestals are advisable.
 - Robotic sensors (for safety and performance) need to be robust and withstand large variations in temperature and humidity. The design and placement of sensors should allow for the easy installation and removal of protective sleeves (or similar) to ensure the technology is not damaged (e.g. from airborne particles and moisture).
 - Teach pendants and computer interfaces require sufficient visual contrast to support user attention to the colours of text and background material (e.g. darker text on a lighter background is more readable than its inverse and black text on white background provides greatest readability). Equally, to avoid eye fatigue utilise technology options that minimise display flickering and blue light emission, and ensure eyes are typically looking slightly downwards at the display (to avoid dry eyes).
 - Voice commands to interact with cobots may have limited applicability and should not be the main method of communication. Similarly, if relying on verbal instructions or communication to operate a cobot, earphones/headsets should be of a high standard (include noise cancelling functionality) and thoroughly tested in the actual environment. Ideally, touch screens need to cater for wearing gloves or other relevant PPE.
- Robotics manufacturers should continue to develop a versatile offering, including smaller and more flexible robotic set-ups. An unbiased summary user guide for industry on the suite of collaborative robot technologies available would be beneficial. Better understanding of the potential delineation between suitable applications for cobotic systems and exoskeletons is also desirable.



Support for personnel

- Accessible, well-designed instructions (e.g. providing text and images) with accompanying video should be provided by manufacturers and tailored as needed by businesses to share among their users. Good interface design will also minimise unnecessary cognitive load (processing demands/mental effort) when learning and using the interface. Key principles for enhanced interface design and user experience include (Nielsen, 2020):
 - Match between system and real world: speak/write in user's language, ensure familiar terms and concepts; present information in a logical order
 - Consistency and standards: check expectations from similar products/interfaces, e.g. categorisation – colour; spatial consistency – layout
 - Recognition rather than recall: avoid user need to remember information from one part of the interface to another
 - Cater for experienced and inexperienced users; provide choice in how processes are completed
 - Aesthetic integrity: keep design simple and focused on essential information.

Change management

- A greater understanding of change management principles and adoption of change management models can help to accelerate the successful uptake and diffusion of new technologies. Some frequently adopted models (Ohio University, 2020) include the Kubler-Ross Change Curve (MindTools, n.d.; T. J. Smith, 1994) and the Prosci ADKAR Model (Prosci, n.d.). Important components include:
 - Clearly articulate the reasons for change
 - Communicate small amounts of information often to avoid personnel feeling overwhelmed
 - Listen carefully and respond sensitively to employees' feelings and concerns
 - Provide both technical (e.g. cobot programming) and personal development (e.g. growth mindset) training and allow time for employees to explore and experience the technology without expecting initial high productivity
 - Seek ongoing feedback from employees throughout change to identify and address any unforeseen issues early.

Contents

KEY FINDINGS	I
RECOMMENDATIONS	IV
PREAMBLE	VIII
1 THE ROLE OF HUMAN FACTORS IN TECHNOLOGY ADOPTION	1
1.1 THE HUMAN FACTORS APPROACH.....	1
1.2 INDUSTRIAL RELEVANCE OF COLLABORATIVE ROBOTS.....	2
1.3 INTRODUCTION TO COBOT-ASSISTED INDUSTRIAL TASKS	3
2 THE COLLABORATIVE ROBOT TRIAL	6
2.1 TASK BACKGROUND AND AIMS.....	6
2.2 METHODOLOGY.....	6
2.2.1 <i>The dispensing task</i>	7
2.2.2 <i>Anthropometric design</i>	9
2.2.3 <i>Task evaluation</i>	10
2.2.4 <i>Participants (end-users)</i>	13
3 EVALUATION OF THE TWO DISPENSING METHODS	16
3.1 PERFORMANCE METRICS	16
3.1.1 <i>Workload</i>	16
3.1.2 <i>Musculoskeletal risk</i>	18
3.1.3 <i>Product consumption</i>	19
3.1.4 <i>Efficiency</i>	20
3.1.5 <i>Quality</i>	20
3.1.6 <i>Cycle time: Parts per minute</i>	22
3.2 USER PERCEPTIONS AND FEEDBACK.....	23
3.2.1 <i>Manual task completion</i>	23
3.2.2 <i>Cobot-assisted task completion</i>	25
3.2.3 <i>Overall task preference</i>	27
3.3 RESULTS SUMMARY AND REAL-WORLD IMPLICATIONS	28
4 ACCELERATING THE UPTAKE OF COLLABORATIVE ROBOTS IN INDUSTRY	31
4.1 FORCES FOR CHANGE: DRIVING FORCES	31
4.2 FORCES RESISTING CHANGE: RESTRAINING FORCES	32
4.2.1 <i>Resources (Cost)</i>	32
4.2.2 <i>Limitation of applications</i>	32
4.2.3 <i>Industrialised work environment</i>	33
4.2.4 <i>Support for personnel</i>	35
4.2.5 <i>Change management</i>	36
5 CONCLUSION AND FUTURE DIRECTIONS	38
APPENDIX A – PILOT STUDY	39
APPENDIX B – STATISTICAL ANALYSIS	40
APPENDIX C – INDIVIDUAL GLUE-BEAD PERFORMANCE ANALYSIS	42
REFERENCES	44



List of Figures

FIGURE 1: THE FIVE KEY PHASES OF THE COLLABORATIVE ROBOT TRIAL AND WHAT THEY INVOLVED.....	7
FIGURE 2: GLUE PATH FOR DISPENSING TASK.....	7
FIGURE 3: EXAMPLE OF MANUAL COMPLETION OF THE GLUE PATH.....	8
FIGURE 4: TEACH PENDANT AND ITS GRAPHICAL USER INTERFACE (GUI), AND ROBOTIQ Co-PILOT/ACTIVE DRIVE.....	9
FIGURE 5: 3D-PRINTED PLASTIC HAND-GUIDING TOOL WITH INSERTABLE LASER TO INDICATE POSITION ON PATH.....	9
FIGURE 6: TEACHING THE GLUE PATH WAS FOLLOWED BY THE COBOT DISPENSING THE GLUE.....	9
FIGURE 7: BASIC DETAILS OF THE ERGONOMICALLY DESIGNED HANDLE.....	10
FIGURE 8: SIMULATION OF FILM SETUP FOR THE TRIAL.....	11
FIGURE 9: GLUE-BEAD QUALITY ASSESSMENT FOR PARTICIPANT 2.....	13
FIGURE 10: PARTICIPANT BACKGROUND AND EXPERIENCE (N=19).....	14
FIGURE 11: HIGHEST EDUCATIONAL ATTAINMENT BY PARTICIPANTS (N=19).....	14
FIGURE 12: AWARENESS LEVEL OF COLLABORATIVE ROBOTS (COBOTS) PRIOR TO TRIAL (N=19).....	15
FIGURE 13: PERCEIVED WORKLOAD DURING A PRECISION DISPENSING TASK, BY TASK METHOD.....	18
FIGURE 14: RAPID UPPER LIMB ASSESSMENT (RULA) POSTURE RATINGS, BY TASK METHOD.....	19
FIGURE 15: PATHS WITH GLUE BEAD ERRORS, BY ERROR TYPE AND DISPENSING METHOD.....	21
FIGURE 16: THE WORKSPACE FOR THE TRIAL.....	24
FIGURE 17: PERCEIVED EASE OF USING COLLABORATIVE ROBOTS (COBOTS) (N=19).....	27
FIGURE 18: WILLINGNESS TO USE COLLABORATIVE ROBOTS (COBOTS) IN THE FUTURE (N=19).....	28
FIGURE 19: PERCEIVED USEFULNESS OF COLLABORATIVE ROBOTS (COBOTS) (N=19).....	31
FIGURE 20: FREQUENCY OF COMPLETING PHYSICAL TASKS THAT REQUIRE PRECISION IN A TYPICAL WORKDAY (N=19).....	33
FIGURE 21: FREQUENCY OF PARTICIPANT EXPERIENCE OF JOBSITE CONDITIONS (N=19).....	34

List of Tables

TABLE 1: COMMON APPLICATIONS FOR COBOTS.....	3
TABLE 2: SELECTED COBOT IMPLEMENTATION CASE STUDIES.....	5
TABLE 3: OVERALL RAPID UPPER LIMB ASSESSMENT (RULA) SCORE – CORRESPONDING RISK AND ACTION LEVEL.....	12
TABLE 4: CRITERION FOR ASSESSING GLUE BEAD QUALITY.....	12
TABLE 5: COMPARISON OF KEY PERFORMANCE METRICS BETWEEN TASK METHODS.....	17
TABLE 6: COMPARISON OF TYPES OF GLUE BEAD ERRORS BETWEEN TASK METHODS.....	22
TABLE 7: MANUFACTURING KPIS – GLUING METHOD CYCLE TIMES.....	22
TABLE 8: ASSUMPTIONS OF NON-PARAMETRIC ALTERNATIVES TO THE PAIRED SAMPLES T-TEST.....	40

Preamble

Manufacturing is the seventh largest industry in Australia (AI Group, 2019). While the sector has faced considerable competitive pressure over the last decade, substantial investment in the Australian maritime shipbuilding sector is a catalyst for sharp growth in low volume, high-value manufacturing over the next five years. BAE Systems Maritime Australia is at the centre of this through the Hunter Class Frigate program.

This report is one outcome of a major research partnership between BAE Systems Maritime Australia, Flinders University and the Innovative Manufacturing Cooperative Research Centre (IMCRC) - a not-for-profit initiative of the Commonwealth of Australia. The IMCRC has partnered with Flinders University and BAE Systems Maritime Australia to conduct research into accelerating the uptake and diffusion of Industry 4.0 (I4.0) in shipbuilding and the Australian manufacturing industry. This multi-year collaboration involves the application of a human factors and ergonomics (HFE) approach to the adoption of advanced technologies.

Human-machine interfaces are an omnipresent, critical component of I4.0 technologies and accentuate the need for HFE evaluation to achieve successful uptake and diffusion. Moreover, I4.0 technologies possess inherent adaptability which creates ongoing opportunities for application in low volume and high mix manufacturing settings, including shipbuilding. Collaborative robots (cobots) have been identified as a key I4.0 technology which could improve productivity, job design and safety in harsh ('dull, dirty and dangerous') work environments.

This report presents findings of a research trial comparing a manual and cobot-assisted dispensing task. It involves an innovative combination of methodologies that might be systematically applied in support of new technologies in a range of manufacturing sub-sectors.

It is anticipated that the outcomes of this trial will provide HFE (and some technical) insights which are of value to those who currently utilise cobots in their business, and to those considering the potential adoption of this technology.

We are grateful to all those who participated in the trial.

Professor John Spoehr,

Director,

Australian Industrial Transformation Institute

Our lead industry partners involved in the implementation of this project include Sharon Wilson (Continuous Naval Shipbuilding Strategy Director), Evangelos Lambrinos (Exports and Innovation Manager), Andrew Sysouphat (Principal Technologist - Hunter Class), Ivor Richardson (Project Manager – Strategic), Tom Snowden (Project Manager – Industry 4.0 Trials), and Mark Francis (Project Manager). Collectively we thank the Board of the IMCRC and David Chuter, CEO for their support for this project. We share their vision for growth of advanced manufacturing in Australia.



1 The role of human factors in technology adoption

1.1 The human factors approach

The discipline of human factors and ergonomics (HFE) applies systems thinking to real-world problems where the person is considered one of the most critical parts of the system; it takes a holistic approach where the person, task, tool/equipment/technology and environment all interact to influence performance. HFE is focused on user perspectives and primarily aims to make work easier/less effortful and safer for employees and to fit the task to the person to achieve better performance. Thus, HFE seeks to deliver both productivity and wellbeing gains (O’Keeffe, Moretti, Hordacre, Howard, & Spoehr, 2020)

There is relatively strong support for the role that HFE plays in improving worker job satisfaction and reducing the numbers and costs of injuries and absenteeism. However, more evidence is needed to understand the value of HFE in improving productivity, efficiency, product and service quality, performance reliability and sustainability of production. In order to generate these insights, HFE needs to be viewed and evaluated in terms of broader business functions and investment, rather than solely within the domain of work health and safety (O’Keeffe et al., 2020).

HFE involves understanding and examining human capabilities (e.g. sensory processing, cognitive/physical load and decision making) and task requirements. To achieve this, a combination of participatory data collection methods is typically used. These methods include (Cresswell, Blanford, & Sheikh, 2017), but are not limited to:

- observations – provide understanding of what people do in practice
 - e.g. some physical assessment scales such as the Rapid Upper Limb Assessment (see Section 2.2.3) rely on observer ratings
- self-report surveys, interviews, focus groups – allow people to provide details of their perceptions and experiences
 - e.g. surveys can include quantitative scales such as the NASA Task Load Index (see Section 2.2.3) and qualitative/free text survey questions/feedback opportunities
- task analyses – systematically decompose tasks into sub-tasks to assess sequences and performance impacts (e.g. errors, mental workload)
 - can facilitate the identification of task bottlenecks and high demand elements which may induce errors, frustration and fatigue (Annett, 2004)
- system usability/heuristic evaluations – employ a checklist approach regarding characteristics of technology interfaces.
 - e.g. Nielsen (2020) identified ten key principles for enhanced interface design and user experience.

The findings generated from these methods should form recommendations to improve system and job design as well as increase the likely success of technology implementation. This report aims to do just that – it integrates multiple data collection methods to provide a summary of both performance metrics and user feedback relating to an application of a collaborative robot (cobot) for an industrial-type precision production task, concluding with recommendations for accelerating the uptake of I4.0 technology in both the shipyard and manufacturing more broadly. HFE forms part of a wider system of informing decisions about the introduction and operation of new technologies and processes in workplaces. It complements value proposition and businesses case development which are not the focus of this project.

1.2 Industrial relevance of collaborative robots

The cobot was first conceptualised in the late 1990s (Colgate & Peshkin, 1999) and commercial cobots started appearing in the late 2010s (Pittman, 2021). Cobots are speed and force limited industrial robotic arms that are designed with reduced pinch-points, smooth joint-shell designs, and include built-in safety sensors. They are typically smaller and less powerful than traditional industrial robotic arms and correspondingly have reduced payloads and slower operation. Such design elements enable a cobot to stop if it collides with an operator or item in the workspace. Simplified technical aspects also streamline an operator's programming knowledge requirements and facilitate easy integration of peripheral devices such as end-effectors¹ and additional safety equipment (Bloss, 2016).

In recent years, cobots have become a mature platform at the forefront of I4.0, supporting rich ecosystems of 3rd party software and hardware. These associated digital technologies (such as cameras, lasers and sensors) enable advanced collision avoidance and touch detection to optimise workflow. Cobots are often programmed and controlled through tablet-like teach pendants. Hand-guiding "programming" modes facilitate easy redeployment by human operators and support programming reconfigurability (that enables mass customisation of products during production) which is essential to competitive advantage in a global economy.

Cobots are widely used to partially automate manufacturing processes that are ergonomically challenging or difficult to fully automate (Manning et al., 2021). Common applications for cobots, and as observed in the local South Australian manufacturing industry, include (Aaltonen & Salmi, 2019; Farkas, 2020; Kildal, Tellaeche, Fernandez, & Maurtua, 2018; Manning et al., 2021):





- pick-and-place and assembly (e.g. label placement on products at Electrolux, and switchboard assembly at Clipsal Schneider Electric);
- machine tending such as the delivery of raw materials and removal of finished parts (e.g. hopper feeding at REDARC Electronics, and CNC machine tending at Kennewell CNC Machining);
- packaging and palletising in preparation for distribution/shipment: (e.g. preparation of seasonal wines at Penfolds for distribution); and
- process tasks involving following a fixed path: (e.g. welding, gluing and dispensing operations).

Internationally, automotive manufacturers such as BMW Group, Audi, Volkswagen, Nissan and Skoda use cobots in their work cells collaboratively alongside human workers for tasks such as assembly, dispensing, finishing, machine tending, material handling, welding and more (Table 1) (BMW Group, 2013; KUKA, 2016; Robotics and Automation News, 2017; Universal Robots, 2018; Winkelmann, 2017).

¹ An end-effector is an apparatus at the end of a robotic arm that facilitates interaction with its environment.

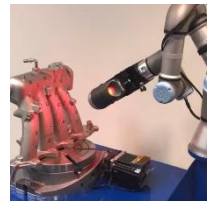

Table 1: Common applications for cobots

Task name	Pick and Place	Machine-Tending	Palletising	Tool-pathing Tasks	Quality Inspection
Image of Task					
	(Techman Robot YouTube Channel, 2019)	(DOIG Corp., 2021)	(RT Robotics AB YouTube Channel, 2020)	(The Robot Report YouTube Channel, 2019)	(NeoMetrix Technologies Inc., 2017)

1.3 Introduction to cobot-assisted industrial tasks

The ‘safety first’ design methodology of the cobot means reduced risk assessment burdens, cost savings on cobot cell equipment such as safety fences and the implementation and auditing of procedures (ISO, 2011a, 2011b) as well as an overall reduction in required floor space - which comes as a premium in the manufacturing industry (Martin, 2020).

The degree of collaboration between human and robots can vary. Four levels of collaboration have been identified (Aaltonen & Salmi, 2019): no coexistence (physical separation - i.e. traditional industrial robots); coexistence (human works in partially or completely shared space with the robot, no shared goals, human and robot activities are unrelated); cooperation (human and robot work towards a shared goal in partially or completely shared space); and collaboration (human and robot work simultaneously on a shared object in shared space). Despite being termed collaborative robots, current evidence suggests that these robots are typically being applied in industry at fairly low levels of collaboration (Aaltonen & Salmi, 2019), such as coexistence or cooperation.

In general, humans are not well-suited to tasks requiring endurance, strength, repeatability and precision (L. Wang et al., 2019). Given these limitations to human task performance, tasks and processes involving these aspects are most likely to benefit from the application of cobots. Key drivers for industry to adopt cobots primarily relate to improved business competitiveness and improved work conditions for employees. For example (Bauer, Bender, Braun, Rally, & Scholtz, 2016):

- increased productivity/operational efficiency (e.g. reduced assembly time)
- improved product quality (e.g. clean adhesive bonds, sensitive surfaces, process reliability) and flexibility (e.g. batch sizes)
- improved posture/ergonomics of employees
- reduced monotony/increased task variety for employees and
- increased career longevity for workforce through aiding employees experiencing performance limitations (e.g. via injury or age-related).

Combining the cognitive capacity of a human and the accuracy and repeatability of a cobot has been shown to improve objective quality evidence of output, improvements to product quality and increased consistency in tasks (Vysocky & Novak, 2016; Zanchettin, Croft, Ding, & Li, 2018).

As discussed by Manning et al. (2021), the value proposition for implementing cobots includes:

- allowing people and property to be utilised more efficiently, supporting higher productivity and lower prices (CEBR, 2017)
 - Workers potentially have more capacity to dedicate to higher value tasks; and
 - Humans and robots can share existing space/infrastructure, reducing the need for new capital investment (Deloitte, 2019).
- supporting organisational agility to fluctuating market demands and entering new markets (Kittel, 2019)
 - Cobots can supplement the workforce to diminish the impact of seasonal shortages and variations such as those experienced in agriculture (Drogemuller, 2019).

Table 2 provides a brief summary of some of the more explicit business gains resulting from cobot implementation. However, the authors observe limited availability of evidence, inconsistent and/or incomplete reporting of metrics and contextual factors including lack of clarity around the timeframe of evaluation, number of cobots involved and the precise contribution of individual equipment/technology. The calculation of business outcomes often requires detailed data. For example, to calculate the efficiency of a manufacturing operation (overall equipment effectiveness) numerous metrics are required such as the availability of equipment for production (operating time/planned operating time), the quality of what is being produced (valuable operating time/net operating time) and performance (net operating time/operating time)(Sonmez, Testik, & Testik, 2018). Similarly, return on investment (ROI) calculations can vary in terms of what is included (Gotfredsen, 2017a; Knight, 2015); ROI for cobots should include the amortised cost of the robot, installation (e.g. integration with other machines, programming) and maintenance (Manufacturers' Monthly, 2020).



Table 2: Selected cobot implementation case studies

Company (Country)	Industry	Application (cobot manufacturer)	Business outcome	Source
BWIndustrie (France)	Metal and machining	Machine tending, material handling and removal, quality inspection (Universal Robots)	ROI/Payback period - less than 12 months Revenue increased by 70%	Kantarci (2021); Universal Robots (n.d.)
ALPHA Corporation (Japan)	Automotive	Material handling and machine tending (Universal Robots)	Productivity of automobile key moulding process - improved by 20%	Kantarci (2021)
REDARC (Australia)	Electronics	Machine tending, pallet handling (Universal Robots)	Production capacity – 250% increase (in combination with other advanced manufacturing technology)	Kittel (2019)
Multi-Wing CZ (Czech Republic)	Ventilation fan producer	Machine tending (Universal Robots)	Decreased production cost of each unit by 10-20%	Von Hollen (2019)
Craft and Technik Industries (India)	Automotive parts	Machine tending, inspection (Universal Robots)	Production volume increased 15-20% with no defects or customer rejections	Von Hollen (2019)
Benchmark Electronics (Thailand)	Electronics	Assembly (Universal Robots)	Increased output quality with fewer human errors. OEE improved by 25%; 10% of manufacturing space has been saved. Expected ROI is less than 18 months.	Engineering 360 (2020)
Anonymous	Automotive parts	Machine tending, labelling and packing (Universal Robots)	OEE increased from 72% (average for 12-month period) to 93% (average of 21 days post implementation)	Vido, Scur, Massote, and Lima (2020)
Atria (Northern Europe)	Food and Beverage	Labelling, packing and palletising (Universal Robots)	Payback period – one year	Gotfredsen (2017b)
EVCO Plastics (United States)	Injection Moulding	Pick and place of parts into boxes (unknown)	Reduction of repetitive strain injuries resulting in savings (a lower rate) on workers' compensation insurance	Campbell (2019)

Overall equipment effectiveness (OEE); return on investment (ROI)

However, critical to individual technology acceptance and application, are ease of use and perceived usefulness (Davis, Bagozzi, & Warshaw, 1989). Without understanding and augmenting employee acceptance of technology (cobots in this instance), people may ‘delay, obstruct, under-utilise or sabotage’ its use (Leonard-Barton, 1988, p.604). If end-users are not willing to effectively engage with cobots, the productivity gains and other benefits they offer cannot be realised and investments from businesses cannot be capitalised on. As an emerging technology (AMFG, 2019), particularly in the Australian context (R. Smith, 2018), is it unclear how receptive the current and future workforce will be to applications of cobots. To address some of these knowledge gaps, we investigated a representative cobot application (dispensing task) from a human factor perspective.

2 The collaborative robot trial

2.1 Task background and aims

Dispensing systems (for glues, inks or other liquids and solvents) have several industrial applications in defence, aerospace, automotive, oil and gas and pharmaceuticals (AtlasCopco, 2019). Glue dispensing on component parts, for example, is a common sub-task in automotive and furniture assembly. Industrial glues frequently contain hazardous chemicals to which human exposure should be minimised, including through use of appropriate personal protective equipment (PPE). When this sub-task is completed manually, employees are required to accurately dispense an adhesive bead along, at times, complex paths. The physical demands made on a human engaging in this process often include repetitive movements, fine-motor skills, awkward postures and hand-force application (Colim et al., 2020). These are known risk factors for developing musculoskeletal disorders (ibid.) which remain the leading work, health and safety problem for Australian employers and employees, both in terms of frequency and cost (Oakman, Clune, & Stuckey, 2019). In particular, there can be intensity of exertion in the wrist and hand when applying glue (Colim et al., 2020).

In addition to the health and safety challenges associated with gluing, reliably dispensing a consistent amount of glue within and between component parts can be difficult and may result in reduced quality of adhesion, increased faults and associated need for re-work, increased product waste and potentially increased exposure to hazardous chemicals (Weber, 2019). This can ultimately have a negative impact on employee productivity and job satisfaction as well as business costs. Cobots have the potential to address many of the constraints in human performance and safety concerns associated with manual, repetitive tasks (CSIRO, 2016), such as manual gluing.

Accordingly, conducting a trial where participants can directly compare a manual and cobot-assisted dispensing activity will increase awareness of this technology in the Australian workforce and provide participants with practical experience of the advantages and disadvantages of cobot technology. Specifically, the trial aims to:

- establish the impact of human/cobot interaction on task performance (e.g. quality, efficiency) and safety (e.g. musculoskeletal risk)
- understand usability and acceptance of this technology across a range of populations (e.g. shipbuilders, SMEs, apprentices)
- inform potential future applications of cobots in local settings and
- assist in informing less familiar organisations on the requirements and challenges of integrating and using a cobotic system in daily production.

2.2 Methodology

The trial design uses a within-subjects (repeated measures) methodology where the same participant completed each dispensing method (manual and cobot-assisted). The order for which method was completed first was randomised to account for recency effects (where the method completed last may disproportionately influence the evaluation of the overall experience). Ten of the 19 participants completed the cobot-assisted method first.

The trial was conducted in a non-threatening, controlled (laboratory) environment allowing increased precision of measurement of the concepts of interest with limited distraction and influence from extraneous variables (Fiske & Fiske, 2005). Consistent with the principles of good study design (van Teijlingen & Hundley, 2001), the trial was piloted



with both Flinders University research and BAE Systems Maritime Australia (BAESMA) employees to assess the feasibility and relevance of the process, resources and data management requirements (Cadete, 2017). Refer to Appendix A for outcomes/lessons from the pilot.

The trial process and duration are captured in Figure 1. On average, the total time investment per participant was approximately one hour and ten minutes. Participants were provided with instruction cards and given familiarisation time (practice) for each method prior to completing the test performance. The different task methods are described in more detail in Section 2.2.1.

Figure 1: The five key phases of the collaborative robot trial and what they involved

<p>Research administration requirements:</p> <p>Completion of COVID checklist and hand sanitisation, informed consent, and safe work procedure (10 minutes)</p>	<p>Manual dispensing task:</p> <p>Acquisition of PPE (e.g. safety glasses, nitrile gloves and apron), completion of practice and test performance (10 minutes)</p>	<p>Online survey:</p> <p>Provide perceptions of, and feedback about, manual task and general work conditions (10 minutes)</p>	<p>Cobot -assisted dispensing task:</p> <p>Practice using the hand-guiding tool and obtaining familiarity using the teach pendant interface. Teach the dispensing path and watch cobot play-back. Researcher to perform tool-change before enabling dispensing and watching the cobot dispense the glue. (28 minutes)</p>	<p>Online survey:</p> <p>Provide perceptions of, and feedback about, cobot task and general thoughts on cobots (12 minutes)</p>
----------------------------------------------------------------------------------------------------------------------------------------------------------------------------	-------------------------------------------------------------------------------------------------------------------------------------------------------------------------------	------------------------------------------------------------------------------------------------------------------------------------------	-----------------------------------------------------------------------------------------------------------------------------------------------------------------------------------------------------------------------------------------------------------------------------------------------------------------------------------------------	--------------------------------------------------------------------------------------------------------------------------------------------

2.2.1 The dispensing task

The task centred around a 2D path on A3 paper that was intended to mimic a car door, piece of furniture or hatch of a submarine, for example (see Figure 2). The path was created to be relatively intricate and challenging, incorporating both straight lines, sharp angle changes and shallow/steep curves. The goal of the task was to dispense the 'glue'² as consistently and accurately as possible in the middle of the thick black path (the thickness of the path was used to assist with the post hoc evaluation of path accuracy). The mid-point of the black line was indicated by a thin white dashed line. The same path was used for both the practice and test performance.

Figure 2: Glue path for dispensing task

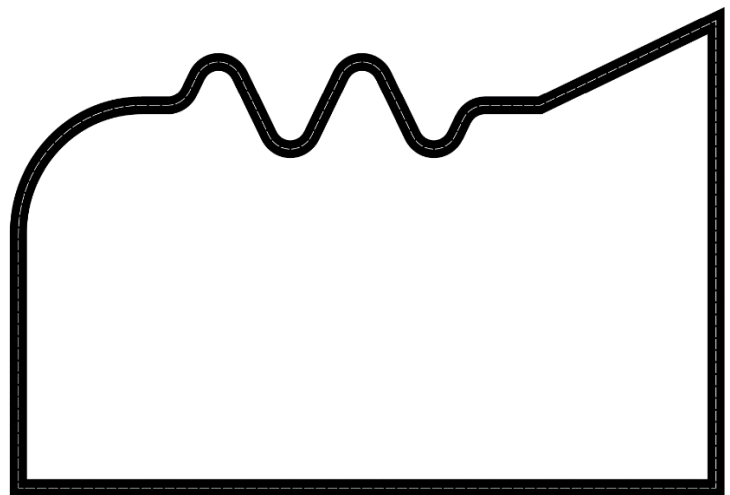

² To minimise risks to participants, a non-hazardous substitute (i.e. Selleys No More Gap) was used. This research trial was approved by the Flinders University Social and Behavioural Research Ethics Committee (Project Number 2697)

Manual method

For the manual method, participants were presented with a Milwaukee cordless caulking gun (see Figure 3). For consistency, the speed was set at 1 (slowest speed) for all participants.

Figure 3: Example of manual completion of the glue path



Source: AITI Photo Stock 2021

Cobot-assisted method

The cobot-assisted method involved hand-guiding a cobot (model, Universal Robot UR10e) to rapidly generate a real space toolpath for dispensing glue. This task involved interacting with the teach pendant, a 3rd party software plugin (see Figure 4) and an in-house designed hand-guiding tool (Figure 5).

The practice period included testing two hand-guiding sensitivities provided through the RobotIQ software package; snail (slow/more resistance) and hare (fast/less resistance). The hand-guiding tool was prototyped and tested to ensure the tool had sound ergonomics – e.g. a comfortable grip and interchangeable support bar to accommodate both right and left-hand dominance/preferences (also see Section 2.2.2). After recording the glue path, researchers would perform the tool-change to the in-house designed dispensing system (which was built around the Milwaukee cordless caulking gun; this allowed for consistency with the manual method). Once this was in place, the participant used the teach pendant to initiate the cobot glue dispensing (see Figure 6). Participants could teach the toolpath at a comfortable speed and they could stop at any time to re-position themselves. The taught path could then be played back at an independent speed – this would filter out any pauses and ensure consistency. The Milwaukee caulking gun was set to 1.66 (slightly faster speed setting than the manual method) to accommodate the relatively reduced compression of the trigger achievable by the cobot dispensing system. The cobot moved at 40mm/s.



Figure 4: Teach pendant and its graphical user interface (GUI), and RobotIQ Co-Pilot/Active Drive



Figure 5: 3D-printed plastic hand-guiding tool with insertable laser to indicate position on path



Source: AITI Photo Stock 2021

Figure 6: Teaching the glue path was followed by the cobot dispensing the glue



Source: AITI Photo Stock 2021

2.2.2 Anthropometric design

Understanding the physical dimensions of human beings (anthropometry) is important to optimise the fit and function of products, as equipment that is the right size for users will be more comfortable and easier to use. Three main strategies are usually applied to achieve this – design

for the average (also see Section 2.2.4), design for adjustability or design for extremes (Center for Occupational and Environmental Health (COEH), n.d.). This trial adopted the first and second strategy as much as possible. The *human factors and ergonomics design handbook* (Tillman, Fitts, Woodson, Rose-Sundholm, & Tillman, 2016) and *Hand tool handle design based on hand measurements* (C.-Y. Wang & Cai, 2017) were consulted for human anthropometric data which allowed the design to be optimised e.g. handle length & width, shaft angle and diameters (see Figure 7 for specifications used for males and applied in this trial³).

Figure 7: Basic details of the ergonomically designed handle

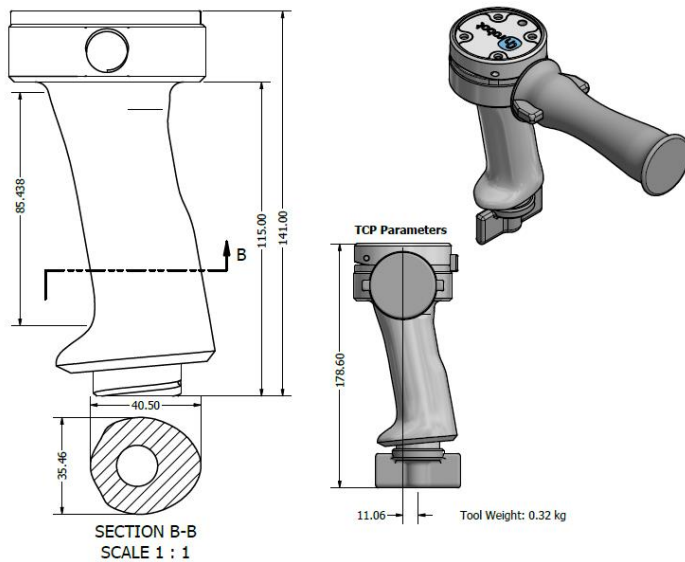

Source: Designed in-house by AITI

The work surface was a height-adjustable rectangular desk (83cm deep x 120cm long). For the trial, it was set to its maximum height (surface was 90cm from the ground). Participants were asked if they wanted to lower the height, although no one did for the trial.

2.2.3 Task evaluation

In addition to adopting an holistic HFE approach for the trial (see Section 1.1), effective evaluations collect different types of data (often referred to as a mixed-method study) to deepen understanding of the results and to help explain and verify the findings (Greene, Caracelli, & Graham, 1989; Onwuegbuzie & Leech, 2005). The trial involved multiple types of data which were collected in parallel (at the same time). For the purposes of this report, they can broadly be categorised into performance metrics and observations, user attitudes and feedback.

Performance metrics

These measures relate to assessments which provide a quantitative (numeric) output which can be statistically compared across participant groups and different task domains. Standard tools and methods were applied.

³ Manufacturing and construction are male-dominated industries (Workplace Gender Equality Agency, 2019).



- **Workload**

The *NASA Task Load Index (TLX)* (Hart & Staveland, 1988) is a subjective workload assessment tool which, in recent times, was declared the most cited survey measure of workload (Grier, 2015). It is a six-item tool which allows participants to indicate their perceptions of mental demand, physical demand, temporal demand (pace of task), overall performance in achieving a task goal, effort required to achieve that level of performance, and frustration level (how stressed, discouraged, insecure or irritated the participant felt during the task).

Each workload dimension is rated on a 21-point scale, anchored at 0 (low) to 20 (high) where each increment has a value of five, representing an overall scale between 0 (low demands) and 100 (high demands). The six subscales are summed and averaged to provide an estimate of overall workload (Hart, 2006). This forms a raw, unweighted score which is commonly used and considered simpler and just as useful as the more traditional weighted score (ibid.).

A task receiving an overall rating of 30 or below is considered to have low demands – scores above this are considered to have high demands (Bernard, Zare, Sagot, & Paquin, 2020). Tasks involving frequent or extended periods of high demands can result in reduced work effectiveness and compromise safety (e.g. through fatigue, and reduced concentration from multi-tasking).

- **Musculoskeletal risk**

Two cameras on tripods were set up to simultaneously capture task completion from a side view (viewing angle of 90 degrees) and from behind (viewing angle of 0 degrees; see Figure 8). This footage was retrospectively assessed by an ergonomist using the *Rapid Upper Limb Assessment (RULA)* tool (McAtamney & Corlett, 1993). The RULA provides a systematic guide to evaluate body posture, force and repetition involved for a job task and to identify worker exposure to risk factors associated with upper extremity musculoskeletal disorders (Middlesworth, n.d.).

Depending on the nature of the task, separate observations may be needed for both left and right sides of the body, influenced by the frequency and variability of postures, forces and movements. Highly dynamic tasks generally require both sides of the body to be evaluated, while dominant hand activities generally require assessment only of the active side that has greatest exposure to musculoskeletal risk factors (Middlesworth, n.d.).

The assessment includes analysis of postures in the upper and lower arm and wrist (Posture Score A) and neck, trunk and leg (Posture score B). Score A and B are adjusted for muscle use and force/load to produce Score C and D, respectively. These two scores are then assessed together using a matrix table to generate an overall score (McAtamney & Corlett, 1993). The overall score corresponds to an action level which is summarised in Table 3.

Figure 8: Simulation of film setup for the Trial

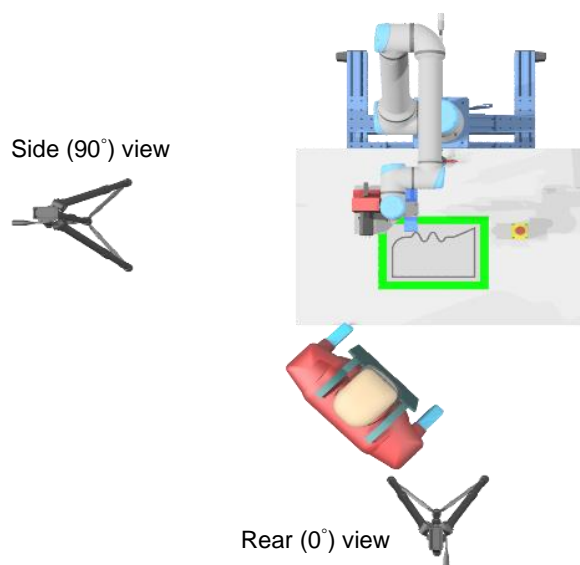

Table 3: Overall Rapid Upper Limb Assessment (RULA) Score – corresponding risk and action level

Score	Risk level	Action level
1-2	Negligible risk	No action required (posture is acceptable if it is not maintained or repeated for long periods)
3-4	Low risk	Further investigation, change may be needed
5-6	Medium risk	Further investigation, changes required soon
7	Very high risk	Further investigation, changes required immediately

Source: Adapted from McAtamney & Corlett (1993) and Middlesworth (n.d.)

- **Product consumption**

The glue cartridge (with nozzle) was weighed before and after completion of the test glue path. It was weighed on high accuracy digital scales which provided measurement to the nearest *gram*.

- **Efficiency**

Using the stopwatch function on a smartphone, the same researcher recorded the time taken to dispense the glue along the complete path. The time was recorded in *seconds*.

- **Quality (accuracy)**

Using the camera of a smart phone, 2D images⁴ of all glue paths were taken after each participant completed the trial. To determine the quality of the glue bead resulting from each dispensing method, a visual inspection assessment framework was developed (summarised in Table 4 and illustrated in Figure 9), informed by current industrial dispensing assessment methodologies (MVtec Software GmbH, 2016), (MultiPix imaging, 2021), (Graco, 2021). Fewer total errors indicate better bead quality/task performance.

Table 4: Criterion for assessing glue bead quality

Error Type	Summary
'No bead'	No bead could be detected at this position.
'Incorrect position'	Deviates outside black line
'Too thin'	Below half thickness of black line
'Too thick'	Exceeds width of black line

⁴ Ideally, consistency of the glue bead height would be included as a criterion of bead quality. A 3D stereo camera was used to capture this information however the data produced too many artefacts and was not considered reliable enough to use in this instance.



Figure 9: Glue-bead quality assessment for Participant 2

<p>p2 - C</p>		<ol style="list-style-type: none"> 1. No bead count: 0 2. Incorrect Position count: 14 3. Too thin count: 0 4. Too thick count: 2
<p>02 - M</p>		<ol style="list-style-type: none"> 1. No bead count: 4 2. Incorrect Position count: 6 3. Too thin count: 3 4. Too thick count: 0

Due to the absence of a vision system on the cobot dispensing unit, a lead-in line (denoted by the dashed oval) was required to ensure dispensing occurred from the start of the path. This was not required for the manual version. This variation should be taken into consideration when evaluating glue consumption (also see Section 3.1.3)

Observations, user attitudes and feedback

These measures provide contextual information to the performance metrics and tend to be more qualitative in nature. The surveys administered contained both rating scales and free-text fields relating to participants' broader work environment and general attitudes to the task and technology used (technology acceptance). In addition, researchers recorded behavioural observations of how participants interacted with the task/ technology and noted any verbal feedback which was provided throughout the trial.

2.2.4 Participants (end-users)

Demographic characteristics

Nineteen people participated in the trial (n=1 female) and the average age was 42.4 years (ranging from 18 to 61 years). All participants had some shipbuilding or production experience (see Figure 10) and had completed education beyond secondary school (see Figure 11). All but one participant spoke English as their first language.

Figure 10: Participant background and experience (n=19)

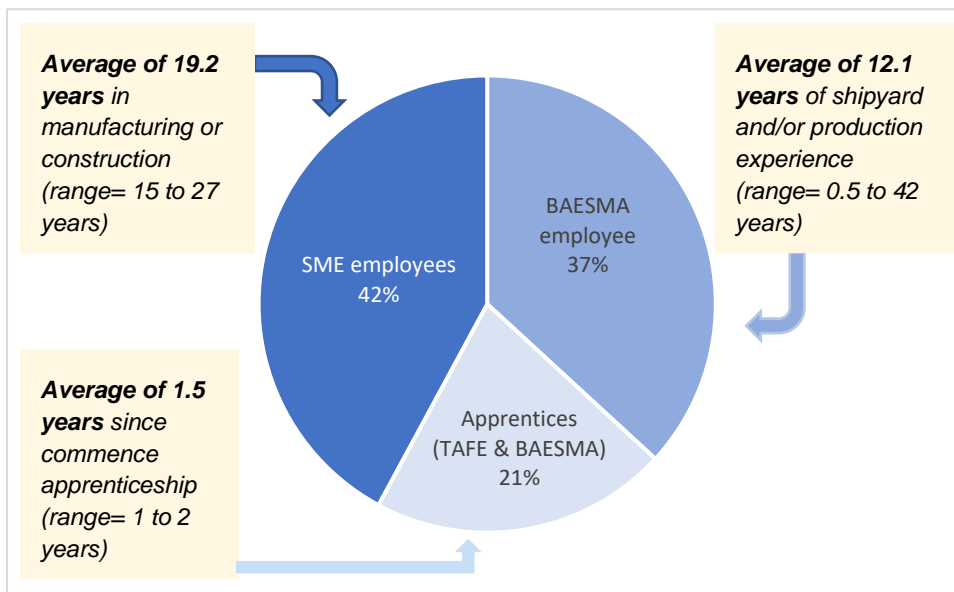

BAE Systems Maritime Australia (BAESMA); Technical and Further Education (TAFE)

Figure 11: Highest educational attainment by participants (n=19)

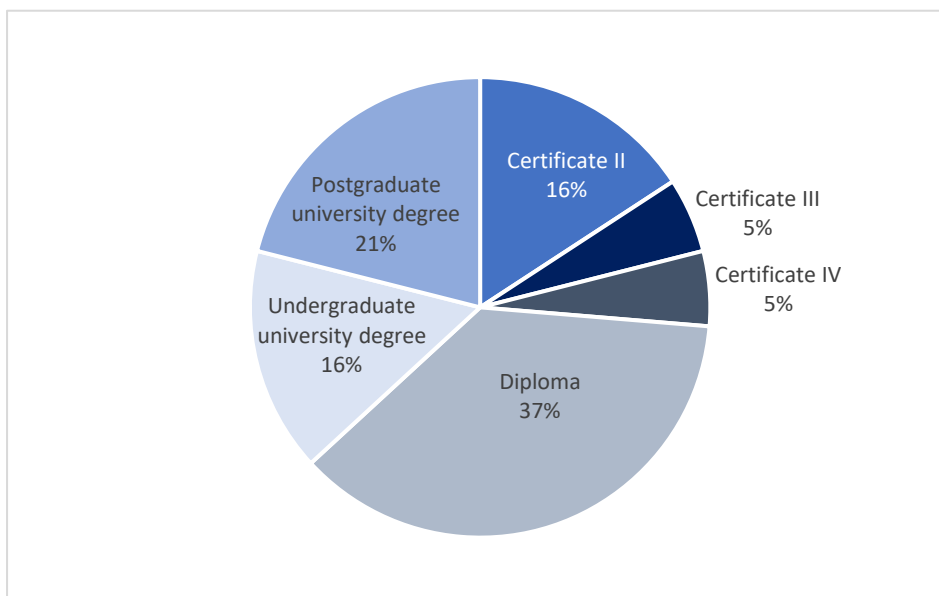

Prior experience with technology

None of the participants had prior experience using a cordless caulking gun but most had used a manual caulking gun. All participants except for one apprentice had heard of cobots prior to the trial and around three out of four participants (74%) were aware of this technology being used in industries relevant to their employment (see Figure 12). Approximately one-third of participants (32%) reported they had worked in a workplace with a cobot relevant to their current employment.



Anthropometric data

One participant was left-handed⁵. The average approximate (self-reported) height of male participants was 181.4cm (ranging from 170cm to 194cm), slightly taller than recent, available anthropometric data for Australian males⁶. The female participant was 169cm tall, taller than the average Australian adult female⁷.

Figure 12: Awareness level of collaborative robots (cobots) prior to trial (n=19)

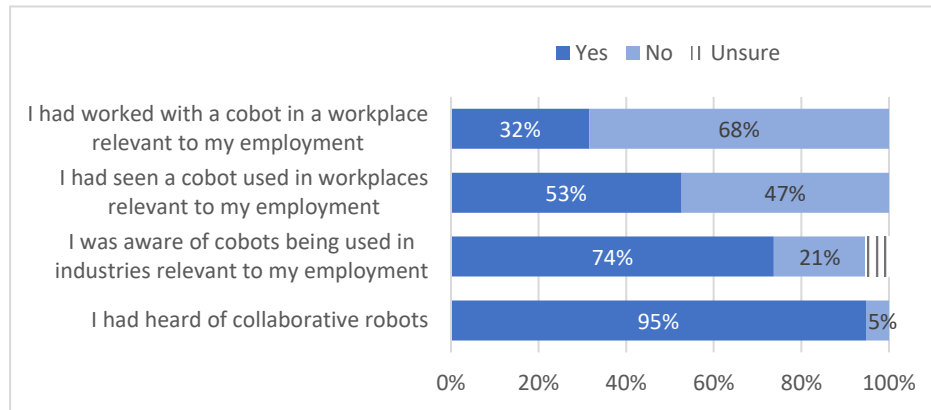

⁵In this small sample, this equates to half the proportion of the best overall global prevalence estimate (10%; Papadatou-Pastou et al., 2020)

⁶ 175.6cm tall in 2011-12 (Australian Bureau of Statistics, 2012) although has been reported to be 179.2cm in 2019 (Ratini, 2019).

⁷ 161.8cm tall in 2011-12 (Australian Bureau of Statistics, 2012)

3 Evaluation of the two dispensing methods

3.1 Performance metrics

3.1.1 Workload

In general, both task methods were considered to place low demands on users (i.e. average scores were less than 30; see Section 2.2.3). Nevertheless, the cobot-assisted method was perceived to be significantly less demanding than the manual method (see Table 5). On average, the cobot-assisted method produced a statistically significant decrease in overall workload (mean=19.0) compared to the manual method (mean=33.5; $t(18)=4.00$, $p<.01$; paired-samples t-test – described in Appendix B). This difference in means is of large magnitude/effect size ($d=.83$)⁸.

When examining the sub-scales of the NASA-TLX (see Figure 13), the manual task was significantly more demanding (higher scores) in every aspect, except with respect to mental demands which were found to be equally low for both (although at an individual level, some participants described the manual method to be quite mentally demanding, see Section 3.2).

For this novel task, relative to the manual method, the cobot-assisted method:

- delivered the greatest median decrease in workload for performance (i.e. participants viewed themselves as being much more successful/accurate using the cobot-assisted method)
- provided a much easier/slower pace (lower temporal demands)
- involved considerably less effort to achieve the level of performance
- placed significantly less physical burden on users and
- resulted in little stress or frustration.

Mean vs Median

The **mean** of a set of values is the sum of all the values divided by the number of values. This figure is most commonly referred to as the 'average' and is most frequently reported.

The **median** or midpoint is the middle value in a set of numbers. It is the value that separates the higher half of values from the lower half of values. The median is useful because it is not influenced by the presence of extremely large or small values and can provide a better understanding of a typical or common value in a data set.

Some statistical tests assess differences between mean scores and some compare median scores. Test selection is based on how the data are distributed (see Appendix B).

Standard Deviation (SD)

The SD reflects how spread out the data are from the mean. A lower SD indicates the data cluster around the mean; a higher SD shows the data are more dispersed from the mean (National Library of Medicine, n.d.). For any distribution, "about 95% of individuals will have values within 2 SDs of the mean" (Altman & Bland, 2005, p.903). See next page for example.

Statistical Significance

Statistical significance indicates that a relationship or result is unlikely to have occurred by chance. Significance levels (probability values) are normally set at:

- **p<.05** ('significant' – only 5% likelihood that the result occurred by chance) and
- **p<.01** ('very significant' – only 1% likelihood that the result occurred by chance).

It is important to recognise that as samples increase in size, so too does the chance that even very small differences between groups can become 'statistically significant'.

⁸ One way to aid interpretation of findings is to calculate the effect size which indicates the strength of a difference or association (the greater the effect size the more likely the finding will be meaningful or of practical importance). When conducting a paired-samples t-test, Cohen's *d* is the most common measure of effect size. As a guide, .2=small effect; .5=medium effect; .8=large effect (Cohen, 1988). The *d* reported here is corrected for small samples but is best interpreted through comparison with other similar studies, where they exist (Bakker et al., 2019); see Appendix B for more information.



Table 5: Comparison of key performance metrics between task methods

	Manual dispensing	Cobot-assisted dispensing
Workload (NASA-TLX)**		
Mean	33.5	19.0
Median	28.3	18.3
SD	18.8	10.3
Range	6.7 – 80.8	5.8 – 40.8
Musculoskeletal risk (RULA Score)**		
Mean	6.0	3.8
Median	6.0	4.0
SD	0.9	0.8
Range	4 - 7	3 - 6
Product consumption (Amount of glue used - grams)**		
Mean	27.4	38.8
Median	22.0	39.0
SD	11.6	8.6
Range	13 - 58	21 - 52
Efficiency (Time taken to dispense glue on path - seconds)**		
Mean	50.5	28.3
Median	51.0	28.1
SD	16.2	0.5
Range	22.7 – 81.5	27.5 – 29.1
Glue bead quality/accuracy (total number of errors)^{n.s.}		
Mean	15.6	14.0
Median	14.0	15.0
SD	6.5	2.6
Range	7 - 32	7 - 17

NASA Task Load Index (NASA TLX); Rapid Upper Limb Assessment (RULA); Standard Deviation (SD)
 Statistically significant paired-samples *t*-test or sign test (see in text and Appendix B for details) - **p*<.05, ***p*<.01,
n.s. = Not significant

Standard Deviations (SD) – worked example

Following the example provided by the National Library of Medicine (n.d.), the NASA-TLX results shown in Table 5 suggest that for the manual task, 68% of workload ratings were 33.5 plus or minus 18.8 (1 SD away from the mean); 95% of ratings were 33.5 plus or minus 37.6 (2 SDs away from the mean); and 99.7% were 33.5 plus or minus 56.4 (3 SDs away from the mean). There was less variation in workload ratings for the cobot: 68% of ratings were 19.0 plus or minus 10.3 (1 SD away from the mean); 95% of ratings were 19.0 plus or minus 20.6 (2 SDs away from the mean); and 99.7% were 19.0 plus or minus 30.9 (3 SDs away from the mean).

In summary, the cobot version of the task achieved greater consistency in workload ratings, product consumption, efficiency, and glue bead accuracy.

Figure 13: Perceived workload during a precision dispensing task, by task method

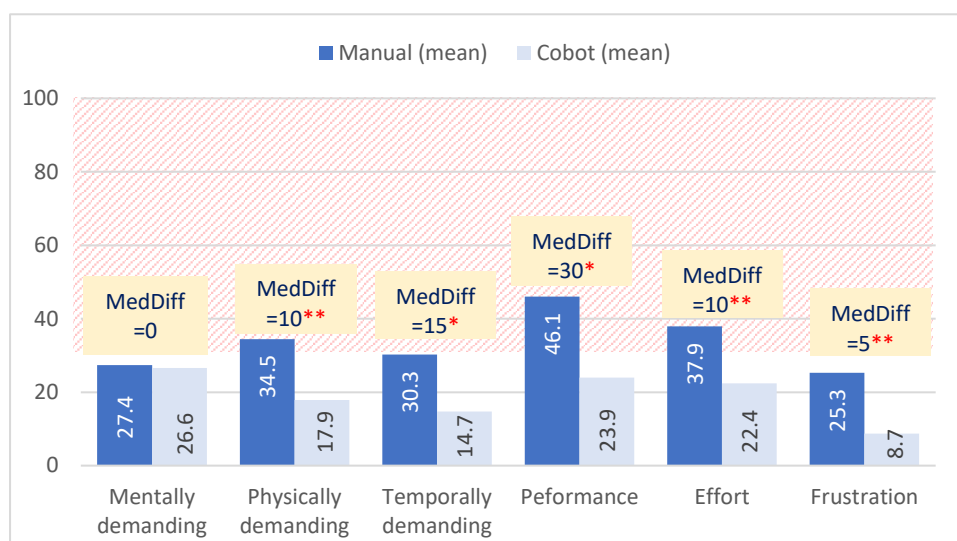

Possible score range is 0 (low demands) to 100 (high demands). Where a response falls into the shaded section, the task is perceived to be high demand (i.e. it has a score of 30 or more).

Median difference (MedDiff) and * $p < .05$, ** $p < .01$, based on a sign test (see Appendix B).

3.1.2 Musculoskeletal risk

Based on the RULA benchmarks (see Section 2.2.3) and as shown in Table 5, the manual method placed participants at medium risk of musculoskeletal injury (indicating further investigation, changes required soon) whereas the cobot-assisted method placed participants at low risk (indicating further investigation, change may be needed). The cobot-assisted method produced a statistically significant median decrease in musculoskeletal risk (3.0 points) compared to the manual method ($p < .01$; sign test – described in Appendix B)⁹. Notwithstanding this overall result, the manual method was associated with an unacceptable level of high-risk scores (around one in four participants was evaluated as having the highest risk score of 7, requiring immediate changes to reduce injury risk). By comparison, in the cobot-assisted task, one person (5%) was evaluated as having a risk score of 6 (changes required soon) with all other scores below this level.

When examining the two posture scores comprising the total RULA score (see Figure 14), the cobot-assisted task placed participants at significantly lower musculoskeletal risk in relation to the ergonomic and biomechanical load on both their arms and wrists as well as neck, trunk and legs. The manual dispensing task presented a greater risk of arm and wrist postural loading due to the design of the caulking gun. Its weight, centre of gravity and length imposed awkward postures and high forces, substantially contributing to higher arm and wrist risk scores. When combined with increased neck and trunk postures arising from the high demands for eye-hand coordination necessary in high precision tasks, the manual dispensing task presents a significant overall risk.

⁹ 90% of participants were rated as displaying lower musculoskeletal risk when completing the cobot-assisted method compared to the manual method; 0% of users were rated as displaying increased musculoskeletal risk when completing the cobot-assisted method and 10% (n=2) were rated as displaying equal musculoskeletal risk during both methods.



Figure 14: Rapid Upper Limb Assessment (RULA) posture ratings, by task method

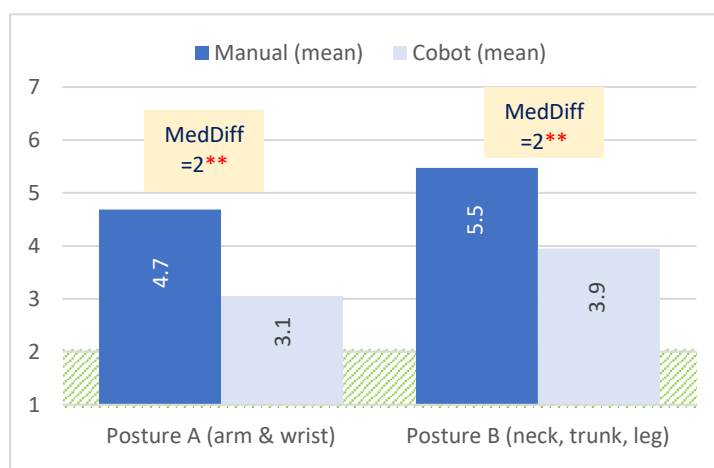

Possible score range is 1 (negligible musculoskeletal risk) to 7 (very high musculoskeletal risk). Where a response falls into the shaded section, the musculoskeletal risk is considered to be negligible. Median difference (MedDiff) and $**p < .01$, based on a sign test (see Appendix B).

One limitation of the RULA risk assessment tool is that it does not account for frequency, familiarity and duration of task performance within the overall job. For a once-only performance of this task, a manual caulking gun presents low risk, but for repeated performance, translates to high risk for musculoskeletal injury, along with the associated impacts on accuracy, efficiency, comfort, and satisfaction. For the purposes of this trial, the manual presentation of the task had several limitations due to the constraints of the laboratory work environment and the novelty of the task for most participants. Ideal presentation of a manual dispensing task should utilise counter-balancing suspension of the caulking gun or an automated dispensing system interfacing with a worktable that is adjustable for height and angle and allows access to work items from all sides. These sorts of improvements were also recognised by some participants (see Section 3.2.1).

Observations of task performance indicate that participants utilised various strategies to assist in maximising precise glue dispensing. Most adopted a slow pace with increased speed during sweeping actions along straight sections of the path. Postural strategies included adopting semi-squat positions to minimise neck and trunk bending postures, supporting body weight by leaning on the table, or frequent changes in foot position to minimise bending. Although the worktable was height adjustable, none of the participants actively made adjustments at the commencement of the manual task (although this may be more likely to occur in a person's workplace). These observations emphasise the necessity for training employees in basic ergonomics and reinforcing the need for correctly setting up a workstation before commencing work. Trial observations provide a snapshot of a controlled environment, but outcomes must also be scaled to job level considering the implications for work design on overall risk, comfort, task efficiency and quality. Cobot-assistance has benefits for eliminating repetitive actions and increasing precision during production runs. While not specifically examined in this trial, the capacity for operators to quickly reconfigure and interact with a cobot has potential to increase flexibility in production planning while minimising risks to human operators.

3.1.3 Product consumption

The cobot-assisted method produced a statistically significant median increase in the amount of glue used (11.0 grams) compared to the manual method ($p < .01$; sign test – described in

Appendix B)¹⁰. This result is likely to be a product of required lead-in time (see Figure 9), stronger/greater compression of the caulking gun trigger by the cobot dispensing unit and increased flow due to gravity/the angle of the caulking gun (90 degrees, see Figure 6). These technical aspects would be refined prior to industrial implementation. We also note that a measure indicating optimum product usage for the task was not considered. If this was provided users may have altered their glue consumption.

3.1.4 Efficiency

The cobot-assisted method produced a statistically significant decrease in the average time taken to dispense the glue around the path (mean=28.3 seconds) compared to the manual method (mean=50.5 seconds; $t(18)=6.02$, $p<.01$; paired-samples t-test – described in Appendix B). This difference in means is of large magnitude/effect size ($d=1.2$)¹¹. However, it is important to note that this time does not include the time taken to teach the cobot the glue path, or perform the tool change – refer to Section 3.1.6 for this detail. It also doesn't take into account the novelty of the task for participants who are likely to improve with some repetition.

3.1.5 Quality

Overall, there was no significant difference in the total number of median errors between the manually dispensed glue bead and the cobot-dispensed glue bead. For approximately half the participants (53%), the manually dispensed glue bead contained more errors; for 42%, the cobot-dispensed glue bead contained more errors and for one participant, there was an equal number of bead errors for each method.

However, the nature of errors for each dispensing mode did vary somewhat. The cobot-dispensed glue beads were very unlikely to have 'too thin' a glue bead (only 5% contained this type of error at all; see Figure 15) or 'no bead' (11%) whereas manually dispensed glue beads showed a greater range of errors with participants least likely to have 'too thick' a glue bead (although this type of error occurred at least once in 47% of manual tasks). In addition, the manual dispensing of the glue bead produced a statistically significant median increase in the number of 'no bead' errors (see Table 6) compared to the cobot-dispensed glue bead ($p<.05$; sign test – described in Appendix B)¹². The manual dispensing of the glue bead also produced a

¹⁰ 90% of participants consumed less glue when completing the manual dispensing compared to when the cobot dispensed the glue; 0% of participants utilised the same amount of glue in each method; and 10% of participants consumed more glue than when the cobot dispensed it.

¹¹ One way to aid interpretation of findings is to calculate the effect size which indicates the strength of a difference or association (the greater the effect size the more likely the finding will be meaningful or of practical importance). When conducting a paired-samples t-test, Cohen's d is the most common measure of effect size. As a guide, $.2$ =small effect; $.5$ =medium effect; $.8$ =large effect (Cohen, 1988). The d reported here is corrected for small samples but is best interpreted through comparison with other similar studies, where they exist (Bakker et al., 2019); see Appendix B for more information.

¹² In 5% of cases, manually dispensed glue beads contained fewer 'no bead' errors than cobot dispensed glue beads; in 53% of cases, manually dispensed glue beads contained greater 'no bead' errors than cobot dispensed glue beads; and in 42% of cases, the number of 'no bead' errors was the same for manually dispensed and cobot dispensed glue beads.



statistically significant median increase in the number of ‘too thin’ errors compared to the cobot dispensed glue bead ($p < .01$; sign test – described in Appendix B)¹³.

Figure 15: Paths with glue bead errors, by error type and dispensing method

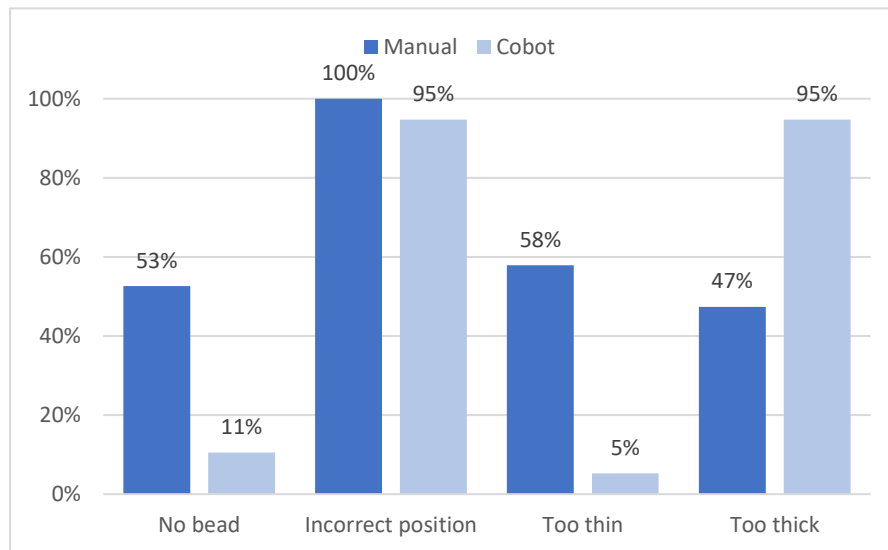

Incorrect position errors were the most common type of error for both the manual and cobot-dispensing. Once taught, the cobot was very precise in executing the path but the dispensing system introduced an error (skew). This was detected and calibrated by the researcher. However, results suggest additional calibration was required to account for subtle changes at different points of the path. Accordingly, we note the dispensing unit would require more specialised refinement prior to industrial implementation.

Overall, based on broad observation of the glue beads by both researchers and participants, the glue bead deposited by the cobot was perceived to have reduced variability (fewer errors, especially with regards to the height of the bead, which was not quantified in this assessment) compared to the human effort. Individual performance plots provided in Appendix C illustrate this reduced variability in errors for the cobot dispensing.

The quality data presented here should be considered as indicative and provides a quantitative snapshot only. The findings summarise the frequency of errors and do not reflect the severity of the different types of errors. In addition, the importance of each error type is likely to vary depending on the context/product involved.

¹³ In 5% of cases, manually dispensed glue beads contained fewer ‘too thin’ errors than cobot dispensed glue beads; in 58% of cases, manually dispensed glue beads contained greater ‘too thin’ errors than cobot dispensed glue beads; and in 37% of cases, the number of ‘too thin’ errors was the same for manually dispensed and cobot dispensed glue beads.

Table 6: Comparison of types of glue bead errors between task methods

	Manual dispensing	Cobot-assisted dispensing
No bead*		
Mean	1.0	0.1
Median	1.0	0.0
SD	1.3	0.3
Range	0 – 4	0 – 1
Incorrect position ^{n.s.}		
Mean	10.8	11.5
Median	10.0	13.0
SD	3.8	3.7
Range	6 - 17	0 - 15
Too thin**		
Mean	1.7	0.7
Median	1.0	0.0
SD	1.9	3.2
Range	0 - 5	0 - 14
Too thick ^{n.s.}		
Mean	2.1	1.7
Median	0.0	1.0
SD	3.5	1.2
Range	0 – 14	0 – 4

Standard deviation (SD); Statistically significant sign test (see Appendix B for details) - * $p < .05$, ** $p < .01$, ^{n.s.} = Not significant

3.1.6 Cycle time: Parts per minute

Cycle time refers to the time taken to complete the production process for one product from start to finish. To ensure the relevance of the trial findings to manufacturing businesses, the following cycle time estimates (see Table 7) have been calculated for each production method of the part (i.e. task). These estimates assume that operators:

- are familiar with the task (i.e. practice time excluded)
- all necessary equipment is in place prior to task commencement (i.e. time to put on PPE and change cobot grippers/end effectors is excluded) and
- the task design does not change.

*The results suggest that the cobot-assisted method is **49% faster** than the manual method.*

Table 7: Manufacturing KPIs – gluing method cycle times

	Manual method	Cobot-assisted method
Parts per minute[#]	$(1/51.0 \text{ seconds}) * 60 = 1.18$	$(1/28.1 \text{ seconds}) * 60 = 2.14$
Minutes to complete 10 parts	$(51.0 \times 10) / 60 = 8.5$	$(28.1 \times 10 + 61.8^{\wedge}) / 60 = 5.7$

[#]Value is median seconds from Table 5; [^]This is the median seconds participants took to teach (i.e. hand-guide) the cobot the glue path. This only needs to be done once per part type/run.



3.2 User perceptions and feedback

3.2.1 Manual task completion

Task demands

Even though most participants described the task as having low complexity, many found the manual task to be more demanding than the cobot version in terms of either mental effort/concentration required, physical effort needed for the weight and trigger of the caulking gun or via greater temporal demands/faster pace due to lack of control over the rate at which the glue was being dispensed. Of note, one participant expressed that it *'was difficult to meter the flow, for example, change the amount of flow by a small amount'*.

There was some recognition after the task about variability in bead accuracy/quality when dispensing manually. One TAFE apprentice shared, *'I found it [the task] to be pretty simple within myself, though I had been quite inconsistent in some places within the practical'* while another expressed, *'practice and instructions were clear, the task itself is not difficult, but the precision is a factor that when doing it manually was horrible when comparing it to the cobot'*.

Task approach

Participants tended to start the glue path (see Figure 2) in either the top right corner (47%) or bottom left corner (37%) and were equally likely to complete the path in a clockwise (53%) or anti-clockwise (47%) direction. Even though participants were encouraged to complete the task in a manner that yielded greatest accuracy, most participants (63%) did not stop/pause their dispensing to reposition or change direction. This may have been a result of the anti-drip feature of the cordless caulking gun which released the pressure through the cartridge upon release of the trigger, creating an inconveniencing delay with variable time required for the gun to 'ramp up' (build up pressure through the caulk cartridge) and start dispensing again.

Some challenges participants identified when completing the manual version of the task included:

- Lack of visibility as to when the glue was dispensing.
 - Although there was a slight pitch change in the motor as the glue was about to be dispensed, it was difficult to visually see the glue approaching the end of the nozzle. This resulted in a somewhat prolonged period of anticipation/sustained attention which was typically followed by a relatively fast flow of glue which caught some participants somewhat off guard.
- Maintaining a consistent motion and relative height to the page.
 - Utilising a table of fixed height (also see Section 2.2.2 and Task environment below) and limiting movement around the path to a single horizontal plane restricted the angle the caulking gun could be applied. In addition, requisite PPE (i.e. nitrile gloves) introduced a degree of friction which interfered with the guiding/support hand at times – an experienced shipyard worker described that *'my gloved hand tended to grip the page'*.

- A closed path prevented working in more familiar ways.
 - Another experienced shipyard worker explained:

Usually if I am caulking I would work left to right, being right handed, as that is how I feel I get the best result. With this being a closed path, this wasn't really an option and found that I was laying the 'no more gaps' in front of the nozzle where I would usually lay it behind the nozzle, which is what I am comfortable with and how I believe I get a better result. The robot dispenses from a vertical position which ergonomically is not an option for a human.

A TAFE apprentice also suggested that working with a flat surface may change how a glue disperses, that is *'in everyday use...gluing wouldn't be done on a flat surface...it would be done in crevices or gaps....a second surface would disperse the glue'*.

Task environment

The work surface for the task was a rectangular table with the participant along one long edge and the cobot positioned along the opposite long edge (see Figure 16). This limited manoeuvrability around the table and with the path centred on the table, positioning oneself at either short edge would have involved leaning/reaching forward. Thus, a few participants indicated being able to move around the table would have been beneficial (although this is not always possible in invivo work situations). However, one participant with shipyard experience identified other issues that this functionality may introduce:

Task may have been improved with a small table allowing increased access around the test page, however moving the body seems to make the application shaky so not sure there.

Figure 16: The workspace for the trial

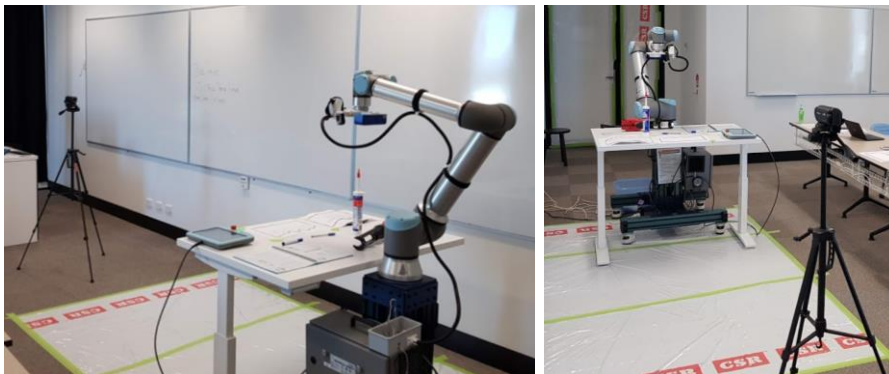

Source: AITI Photo Stock 2021

Device usability

In addition to the limited visibility (system feedback) mentioned in the *Task approach* section above, other design features of the cordless caulking gun which were considered undesirable included its weight which was 2.5kg when loaded with a full glue cartridge. For example, a TAFE apprentice commented that *'it was a very heavy piece of equipment so doing it for a long period of time would wear you out'*. Associated with this, the overall size of the tool (52cm with glue cartridge inserted) and unbalanced centre of gravity made it difficult to aim. For example, a participant who works for a manufacturing SME explained that *'more weight was on the top of the gun which made the task of directing the bead of sealant on to the black line more difficult'*.

Another participant who works for a manufacturing SME suggested the following improvements to the device and environment: *'have a flexible rope to take off the weight of the gun and adjusting table height, plus adding a laser pointer on the gun would help aiming'*.



3.2.2 Cobot-assisted task completion

Task demands

Most participants acknowledged that the task was simple and easily understood with adequate instruction and practice provided (noting no cobot programming was required). Two participants suggested including a short demonstration video to facilitate learning. There was also a suggestion to provide *'additional tasks or patterns to follow with perhaps some start space stop space start patterns'*. During trial development, a range of separate patterns were tested but due to the time burden on operators, these were condensed into one larger, continuous task (as shown in Figure 2).

There was variability in the extent and nature of perceived demands on users. Some expressed an increase in mental demands (e.g. *'use of the cobot required more concentration than simply applying manually'*) whilst others emphasised their experience was relative to pre-conceived ideas and expectations, such as *'the training of the cobot worked well and I found it to be simpler than I imagined prior to starting'*. One participant specified, *'the only less easy part [of the cobot version] would be aiming while moving as it requires good eye-hand coordination'*. A TAFE apprentice identified, despite an initial learning curve, the cobot version of this task offered several advantages:

It was difficult to get used to the machine at first. However, overall it was a lot easier than doing it manually. It was easier to move around and it was a lot lighter making the overall finish more accurate. It was also a lot quicker to complete the job using this machine.

Task approach

During the practice phase of hand-guiding the cobot, participants were able to try a fast ('hare') and slow ('snail') speed setting (as described in Section 2.2). Despite having the option to toggle between these settings when completing the test path, and although some participants recognised that the fast speed may be effective on the straight sections of the path, nobody used this system functionality. All participants chose to utilise the snail mode for the entire test path - as one participant described, this was because it *'gave me better control and less inertia to resist when changing direction'*. This approach may be due to user perceptions that the time and effort involved to change the speed mode would not translate into a significant increase in task quality/accuracy on this occasion and/or lack of familiarity with the system (where perhaps usage of this system functionality would increase with cobot familiarity).

Even though all participants used the slower hand-guiding speed, one participant reflected they *'should have taken a little longer to program path for accuracy'*. This perhaps reinforces the need for businesses to allow sufficient learning time during implementation of such technology so that users can experiment with the technology in combination with task requirements and build knowledge of and trust in their mutual capabilities.

A participant from a manufacturing SME suggested incorporating a swivel mechanism into the hand-guiding tool to cater to both left and right-handed users more efficiently. The hand-guiding tool (see Figure 5) did have this capacity but it could not be modified simply (it required unscrewing the support handle and inserting into the other side of the flange). The left-handed participant did not change the support handle and was comfortable using the right-handed set-up.

Similar to the manual method, participants tended to start the glue path (see Figure 2) in either the top right corner (53%) or bottom left corner (26%) and were equally likely to complete the path in a clockwise (53%) or anti-clockwise (47%) direction. All participants completed the hand-

guiding in one continuous flow although the pace was slower (mean=70.7 seconds; range = 26.3 to 148.8 seconds) than completing the manual path (mean=50.5 seconds, range = 22.7 to 81.5).

Task environment

Although the table was set at its maximum height (see Section 2.2.2), feedback indicated that ideally this was too low for some participants (i.e. $\geq 185\text{cm}$; 37% of participants) although most acknowledged that this would have had little impact for a one-off task.

Upon occasion, the configuration of the cobot task seemed to impair user visibility of the path. This had postural implications at times, for example one participant indicated, '*I was slouching a bit and bending sideways trying to see the path properly*'. In addition, attempts to reposition during the hand-guiding were challenging for some:

At times when I was training the cobot I felt the plane was changing height slightly even though I knew it was not, my focus was sharp on the laser pointer and as I worked to steady my stance and transfer my weight to stay with the cobot it was obviously affecting my balance slightly.

Occasionally researchers observed slightly 'bumpy' transitions as participants repositioned their feet which at times decreased path accuracy briefly. Consequently, footwear, (floor) surfaces and manoeuvrability within a space are key considerations when executing human-cobot precision tasks.

Technology performance, usability and system improvements

Overall, the cobot did not encounter any major system failures and behaved as the researchers anticipated. A couple of participants moved the hand-guiding tool too quickly at the start of the practice phase which caused the robotic arm to activate its safety stop and lock its brakes. This was quickly and easily re-enabled by the touch of a button on the teach pendant. Equally, this event did not seem to alter how participants approached or interacted with the cobot.

Occasionally researchers and participants observed that when the cobot played back the taught path it appeared to 'run wide' in places, not accurately reflecting the taught path. The assumption is that the 3rd party hand-guiding software was applying some very minor path smoothing to optimise the toolpath, which unintentionally influenced accuracy. Only one person decided to re-teach the path because of this. When the taught path is played back, it was set to a constant speed (see Section 2.2.1), rather than the speed at which it was taught. Greater understanding and exploration of the speed/accuracy relationship and parameters when using the cobotic system would be advantageous prior to industry implementation.

A couple of anomalies were also observed during the cobot dispensing of the glue. There were instances of 'bouncing' or slight jerkiness from the cobot when moving around a corner of the path, despite ensuring the nozzle of the caulking gun was the same height from the path each time. On two occasions the nozzle touched the path and squashed the glue bead slightly as it was being dispensed in sections of the path. It is likely that these events are related to introduced error in the calibration of the system such as varying weight of the glue cartridge, the exact position/skew of the caulking gun in the dispensing system (manually inserted each time) and the levelness of the cobot pedestal (the cobot was on a moveable pedestal and had to be set-up each day of the trial activity). Accordingly, a more sophisticated dispensing system would need to be developed for industrial applications.

Responses to survey items (provided after trial activity) suggest that nearly all participants generally expect cobots to be easy to use and operate, with more than one in two strongly endorsing these statements (see Figure 17). The two participants who reported 'disagree' to both of these expectations were from opposite ends of the experience spectrum - a 52-year-old with shipyard experience and an 18-year-old TAFE apprentice. This perhaps



suggests an appreciation of personal limitations with one understanding that context is highly relevant and the other expressing an element of caution, respectively. Participants were less emphatic regarding ‘working with a cobot would be clear and understandable’ with closer to one in three strongly agreeing with this statement. This result may in part reflect reactions by some to the design elements of the cobot system interface (i.e. the teach pendant), as described below.

Figure 17: Perceived ease of using collaborative robots (cobots) (n=19)

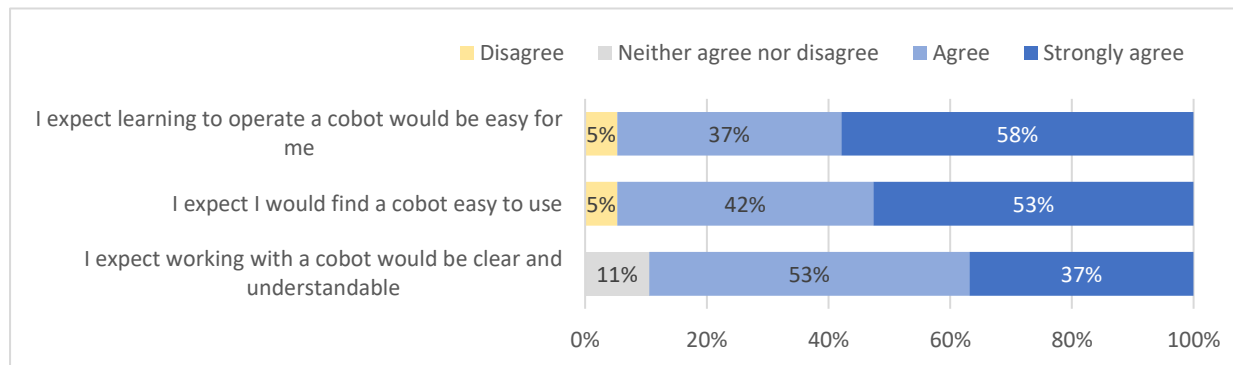

No respondents provided ‘Unsure’ or ‘Strongly Disagree’ ratings for these items.

Even with no prior experience, some participants found using the teach pendant fairly natural and intuitive, for example an apprentice with English as a second language commented, ‘*the collab robots have an easy and friendly interface, which worked well for me, being a first-time user*’. However, two participants found some of the pendant design decisions somewhat counter-intuitive, namely the colour of the active drive icon. Normally in many other real-world applications, a red light signifies ‘stop’ or ‘off’ whereas for the teach pendant it signified ‘on’ or ‘recording’. This could potentially cause confusion, time delays and even injury. One participant who works for a manufacturing SME suggested building an on/off switch into the hand-guiding tool. Another participant who works for a manufacturing SME also indicated minor confusion with the menus of the pendant which displayed more than one ‘play’ button. These errors or sources of misunderstanding reinforce the importance of good design principles (see Section 0). Some frustration was shown by a shipyard worker who let out an audible sigh when commencing reading the instruction sheets for teaching the cobot. He later provided this feedback:

The main difficulty was getting used to the cobot’s programming language¹⁴. The programming in this language is sufficiently nuanced to justify a formal course for the operators.

3.2.3 Overall task preference

Irrespective of which version of the task was completed first, nearly 90% of users preferred completing the precision task using the cobot. Those preferring the manual version of the task (both experienced shipbuilders) qualified that this was associated with the specific trial context where the activity was a one-off. Both these individuals recognised that for larger runs where repetition is greater, the cobot would be a definite advantage. A run size of ten or more was suggested as a threshold between using a manual versus cobot approach.

¹⁴Note, no actual programming was required for the task therefore it is assumed he was referring to the programming interface and may be referring to terminology used, e.g. path node.

Common reasons participants offered for preferring the cobot-assisted dispensing task included:

- **Minimal physical demands:** reduced demands, especially on arms, will likely prevent repetitive strain injuries (supported by musculoskeletal risk assessment, see Section 3.1.2).
- **Improved quality:** recognition that a more consistent application of glue was achieved, facilitated by the cobot dispensing the glue at a constant rate and speed.
- **Increased accuracy:** the cobot allowed increased visibility of the glue path (by applying the glue in a perpendicular position to the path) and provided greater control to the user via the hand-guiding tool.
- **Decreased material waste:** the cobot provides the ability to test/dry run the accuracy of the path without consuming product, as expressed by one individual:

It is possible to review/dry-run, refine/edit a cobot program before application. Manual application is a once only event that cannot be refined during or afterwards.

Less common responses included a perceived reduction of mental concentration, faster operation and, for an SME employee, he considered cobots to have a fun or novelty factor.

Ratings provided to survey items also support this qualitative feedback. Figure 18 shows that none of the participants felt negatively about using collaborative robots in the future.

Figure 18: Willingness to use collaborative robots (cobots) in the future (n=19)

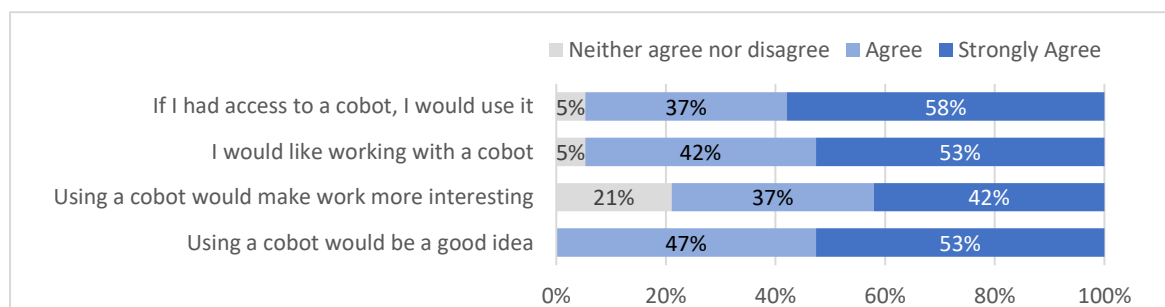

No respondents provided 'Unsure', 'Strongly Disagree' or 'Disagree' ratings for these items.

3.3 Results summary and real-world implications

This trial has demonstrated the capability of a cobot system to increase the productivity of glue dispensing as well as increase human safety when completing this type of task. Thus, the results support some of the benefits cobots are expected to bring businesses (see Section 1.3). In addition, participants also recognised the positive outcomes delivered by the cobot and rated the usability of the cobot favourably with nearly all participants (90%) preferring this method over manual dispensing. However, the researchers and participants alike acknowledge the limitations of a somewhat contrived task within a laboratory environment. It was a brief, simple task that involved working with a two-dimensional 'product' (i.e. glue path on a sheet of paper). Some findings may have changed or intensified if the task had been extended (e.g. manual workload ratings would increase to indicate heavier physical demands and greater musculoskeletal risk). Therefore, we present below some central HFE principles to assist in translating the trial outcomes to real, industrial environments.



Key HFE Principle 1: Performance and design are interdependent. Design factors contribute to 50% to 90% of variation in overall performance; sensory feedback is critical to human-machine performance (T. J. Smith, 1994)

Understanding how users interact with the required tools and equipment in the location of expected use and then tailoring the tools and environment to meet user needs is essential to maximise their performance. Equipment and environmental attributes that were considered to impair performance (reduce quality and efficiency of product) in the current context included:

- Poor tool usability
 - The cordless caulking gun was heavy and awkward (unbalanced weight distribution) to manoeuvre with limited feedback available (unable to view glue proximity to end of nozzle) and some elements having inadequate functionality (anti-drip feature impaired flow/delayed dispensing). There also appeared to be insufficient control over the rate/speed of dispensing.
 - This created increased risk of musculoskeletal strain impeding precision performance, as well as pressure on the user to work quickly. It also hampered selection of a specific performance strategy about how to generate a consistent outcome.
- Surface friction
 - A range of materials impaired the ease with which users could move around the task and environment creating 'bumpy' output at times.
 - This included friction between the PPE (i.e. gloves) and product (i.e. paper) and PPE (i.e. enclosed shoes – often steel cap boots) and floor (i.e. PVC drop sheet).
- Lack of adaptability in and poor accessibility to work surfaces
 - Limited adjustability of the work surface (i.e. table) and limited access to the equipment (access limited to one side), prevented users achieving sufficient leverage and optimal positioning to complete the task.

Further consideration/examination of alternatives to this equipment/set-up is advisable as well as introducing controls that would mitigate their consequences (e.g. have caulking gun on rope to bear some of the weight; design plant layout where equipment can be ergonomically accessed from multiple points).

Key HFE Principle 2: Employee motivation and satisfaction is linked to good job design. Good job design should entail (Hackman & Oldham, 1976):

- skill variety (employee is required to carry out a range of different activities utilising different skills)
- task identity (doing a 'whole' job from beginning to end with a visible outcome)
- task significance (degree of impact on/job salience to other people, either within or external to organisation)
- autonomy (independence and discretion about how work is done) and
- job feedback (employee obtains direct and clear information about the effectiveness of his/her performance).

The dispensing task was not particularly challenging and was considered even less so when completed using the cobot. If doing this one task (either version) for a prolonged period, boredom and errors would likely set in. It is important to balance lower demand aspects of a role with more demanding elements and variety which could include dispensing glue on a range of products (i.e. job enlargement), conducting quality inspection of products (i.e. job enrichment), and/or contributing to the packaging and logistics of products (i.e. job rotation). With technology changing the nature of jobs more rapidly than ever before, it is essential that job design is considered a continuous process with employers regularly reviewing the perceptions of their workforce to the above elements and adjusting where possible.



4 Accelerating the uptake of collaborative robots in industry

Behaviour is a function of the interaction between the person (or group) and their environment (Burnes, 2012). To change human behaviour, the conditions or forces that maintain it need to be altered. According to Lewin’s Field Theory of Learning (ibid.), behaviour at any point in time is a balance in equilibrium between driving forces (facts, features of product, situation that encourage people to want it) and restraining forces (facts, features of product, situation that make people not want to adopt it). To change behaviour and create a new equilibrium, driving forces need to be strengthened and restraining forces diminished (ibid.).

4.1 Forces for change: Driving forces

The benefits typically associated with cobot adoption were summarised in Section 1.2 and tend to focus on improved safety and productivity. More efficient production stemming from the application of a cobot was evident from the trial performance metrics (see Section 3.1) and a range of related sentiments was generally supported by participants (see Figure 19). Participants were most confident that cobots are good for business (89.5% agreed to some extent) and for personal accomplishment in terms of promoting learning and expanding skills (78.9% agreed to some extent). Of the attributes assessed via survey, these appear to be the strongest drivers for employees using cobots with more than one in two strongly agreeing.

Figure 19: Perceived usefulness of collaborative robots (cobots) (n=19)

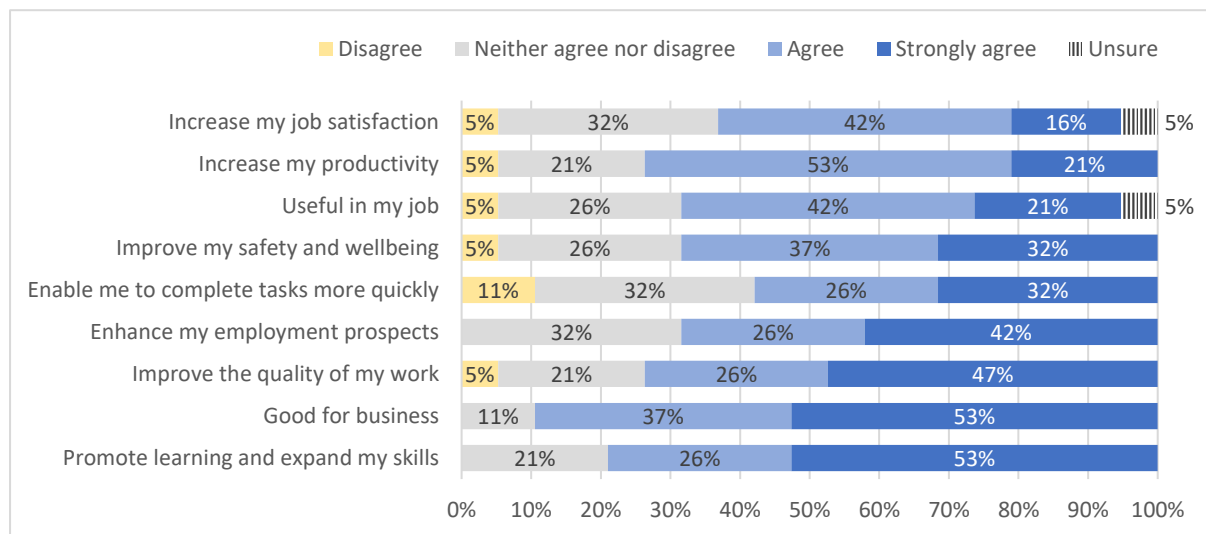

No respondents provided ‘Strongly Disagree’ ratings for these items.

Participants were less confident that cobots would aid faster completion of tasks (around one in ten disagreed that cobots would enable them to complete tasks more quickly) or increase their job satisfaction (only 15.8% strongly agreed). There was reasonable confidence that cobots would improve user safety and wellbeing (around one-third agreeing and one-third strongly agreeing) although more than one in four respondents remained ambivalent (26% neither agreed nor disagreed). Despite an overall positive response to cobotic technology from the trial participants, these findings highlight specific characteristics that could benefit from more detailed assessment and/or effective communication from robotic manufacturers and researchers alike in

order to strengthen driving forces and accelerate broader acceptance in end-users and uptake from industry.

4.2 Forces resisting change: Restraining forces

Via free text survey questions, participants were invited to share their thoughts on what the main barriers to utilising cobots are likely to be in their current workplace. Five broad factors emerged from this feedback as having a negative influence on adoption of cobots. Given restraining forces tend to have a stronger influence on behaviour and are most likely to be responsible for why people don't change their behaviour, we have developed some recommendations to mitigate these and ultimately improve technology adoption by industry.

4.2.1 Resources (Cost)

An Australian automation company has indicated the average cost of a cobot is AU\$24,000 with typical payback times of around six months (Mobile Automation, n.d.). However, this may be an underestimate. Today, cobot procurement is likely to range from AU\$35,000 to AU\$60,000, noting that software plug-ins and end-effectors can be at additional cost.

Cobotic technology continues to improve making more advanced applications more affordable than previously. For some SMEs, this upfront cost can still be prohibitive. Measures of cost effectiveness are related to the extent of applications available to a workplace. The extent of possible applications is both dependent on available technological specifications and human capability to identify and understand appropriate tasks and opportunities.

Adoption Accelerator Recommendation 1: There is a need to develop business cases which incorporate the HFE impact/cost of inaction (i.e. what are the costs to the business of when employees are engaged in 'dull, dirty and dangerous' work?). This may include the savings related to the prevention or minimisation of injury, absenteeism, and disengagement in addition to any productivity gains.

Adoption Accelerator Recommendation 2: Where appropriate, technology trials such as the current study can be used help determine the value and type of investment appropriate for individual businesses.

4.2.2 Limitation of applications

Participants viewed the low force/payload capacity (which allows cobots to be implemented without safety guards), and uncertainty over adaptability to working with specific materials and performance quality (e.g. 'consistency of production quality', 'would the welds be up to standards?') as a limitation for how this technology could be applied in workplaces. Several also believed that cobot applications are rather niche to repetitive tasks in fixed locations which are less applicable to the shipyard:

...cobots are most useful when they are able to be in a fixed position knocking out thousands of the same item. The ship[yard] is not particularly like that, there are thousands of the same things, e.g. studs for mounting brackets, but they are in different locations around the ship. The only way a robot could achieve this work is to be completing these tasks on flat plate before it was formed in some way or placed with the ship itself.



Cobotic applications are limited by and dependent on technical properties (see Section 4.2.3) and the degree of learning support available (see Section 0).

There was support for ensuring that cobots are applied to the 'right' job, which relies on human understanding, vision and sound decision-making. Currently, in existing industrial applications (the most common of which are mentioned in Section 1.2), the level of collaboration with robots remains quite low, such as coexistence (i.e. human works in partially or completely shared space with the robot, no shared goals - the human and robot activities are unrelated) or cooperation (i.e. human and robot work towards a shared goal in partially or completely shared space; Aaltonen & Salmi, 2019). A participant from a manufacturing SME suggested that cobots are best suited to tasks of low complexity:

I think that using a cobot in the workplace would be very useful however I feel many of the jobs in the work area I am in currently wouldn't benefit from these due to the complexity of tasks performed.

Precision tasks are a good candidate for adopting a cobot (see Section 1.2). For trial participants, 42% indicated their work requires them to engage in physical precision tasks either 'most of the time' or 'always' (see Figure 20). More common activities provided requiring this precision include:

- Welding (n=4)
- Calibrating of instruments (e.g. sensors, optical and mechanical components, n=3)
- Cutting, cleaning/polishing/deburring (n=3)
- Wiring electrical circuits (n=3) and
- Measurement (n=2, e.g. to micron level).

Figure 20: Frequency of completing physical tasks that require precision in a typical workday (n=19)

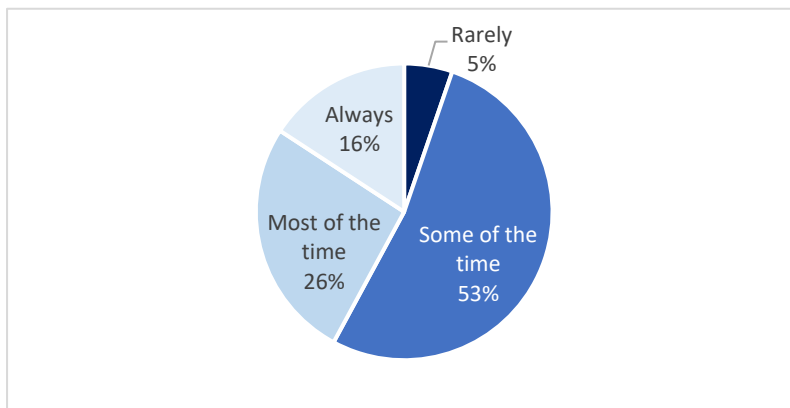

Adoption Accelerator Recommendation 3: Researchers and industry should increasingly collaborate to produce case studies which demonstrate the variety of possible cobot applications, focusing on degree of collaboration and task complexity. Process tasks which may hold most prominence for end-users include welding and polishing.

4.2.3 Industrialised work environment

Of the statements provided (see Figure 21), the most common job site conditions experienced by trial participants were inadequate lighting (16% reported 'always' experiencing this) and extreme temperatures (11% reported 'always' experiencing either hot or cold temperatures). In addition,

more than one in four participants indicated unstable surfaces and loud noise were experienced either 'often' or 'always'. An apprentice in the shipyard also commented that *'with dust, fumes and heavy activity within a shipyard, there may be some issues in the cobots' use in some certain situations'*.

Figure 21: Frequency of participant experience of jobsite conditions (n=19)

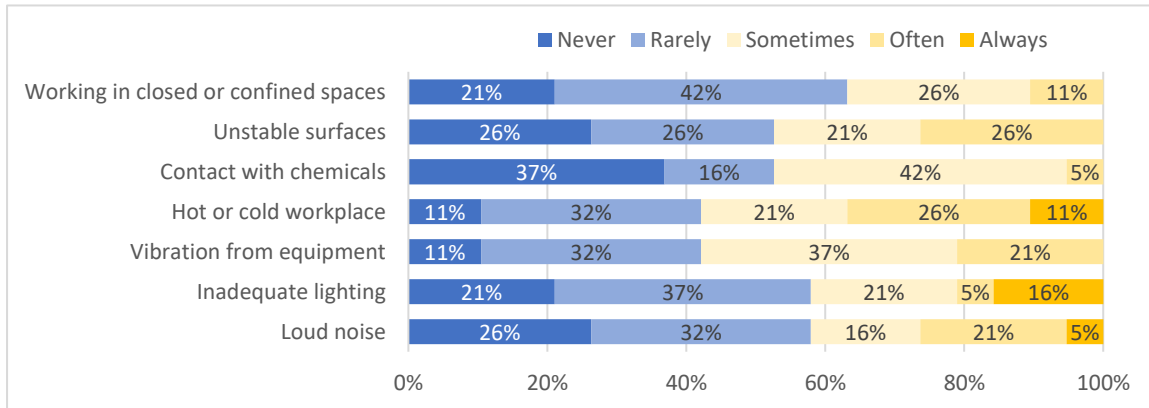

No respondents provided 'Unsure' ratings for these items.

Therefore, to maximise the uptake of cobots in industry, the effectiveness of this technology to meet such environmental conditions or restraints needs to be accommodated and demonstrated. As such the following adoption considerations are proposed:

Adoption Accelerator Recommendation 4: Robotics manufacturers in conjunction with workplaces need to allow design features in teach pendants and robotic computer interfaces that provide sufficient contrast (noting that contrast sensitivity declines with age), paying attention to the colours of text and background material (e.g. darker text on a lighter background is more readable than its inverse and black text on white background, overall, provides greatest readability). Equally, to avoid eye fatigue utilise technology options that minimise display flickering and blue light emission, ensuring eyes are typically looking slightly downwards at the display to avoid dry eyes.



Adoption Accelerator Recommendation 5: Robotic sensors (for safety and performance) need to be robust and withstand large variations in temperature and humidity. The design and placement of sensors should allow for the easy installation and removal of protective sleeves (or similar) to ensure the technology is not damaged from airborne particles and moisture, for example.

Adoption Accelerator Recommendation 6: The pedestal or portable surface on which a collaborative robot is fixed needs to be easily adjustable so that the worktop can be levelled regardless of where the robot is placed. The pedestal that the UR robot was placed on in the trial had a 'screw dial' mechanism without any level feedback/functionality. There were two occasions where it was believed that a non-level set up may have negatively affected the quality of the task output. Built-in spirit levels to all cobot-bases/pedestals is advisable.

Adoption Accelerator Recommendation 7: Using voice commands to interact with the cobot may have limited applicability and should not be the main method of communication. Similarly, if relying on verbal instructions or communication to operate a cobot, earphones/headsets should be of a high standard (include noise cancelling functionality) and thoroughly tested in the actual environment. Ideally, touch screens need to cater for wearing gloves or other relevant PPE.

Through the free text survey questions, several participants (all working in manufacturing SMEs) identified space constraints as a barrier to using cobots. Furthermore, those from both SMEs and the shipyard viewed portability as a significant challenge. Regarding the latter, a participant explained:

Cobots are not light and easily mobile enough to easily work inside a ship. Quickly & simply mounting a cobot securely inside a ship to perform a task is not yet possible.

Adoption Accelerator Recommendation 8: Robotics manufacturers should continue to develop a versatile offering, including smaller and more flexible robotic set-ups (e.g. Boston Dynamics' Spot robot gets an arm (Spectrum IEEE, 2021)). An unbiased summary user guide for industry on the suite of collaborative robot technologies available would be beneficial. Better understanding of the potential delineation between suitable applications for cobotic systems and exoskeletons is also desirable.

4.2.4 Support for personnel

Key selling points often used by robotics manufacturers to promote organisational uptake of cobots include that the technology is fast to set-up (i.e. untrained operators can set-up a cobot in about an hour) and simple to use (i.e. operators do not need programming experience and can quickly program a cobot)(Mobile Automation, n.d.). However, several participants were more sceptical about the realities of implementation, identifying the quality of instruction provided ('instructions need to be written to a level and format that the human operator can understand to be effective') and access to training and support during initial learning ('insufficient training and supporting through teething problems in early stages') as important determinants of successful uptake.

Adoption Accelerator Recommendation 9: Accessible, well-designed instructions (e.g. providing text and images) with accompanying video should be provided by manufacturers and tailored as needed by businesses to share among their users. Good interface design will also minimise unnecessary cognitive load (processing demands/mental effort) when learning and using the interface. Key principles for enhanced interface design and user experience include (Nielsen, 2020):

- Match between system and real world: speak/write in user’s language, ensure familiar terms and concepts; present information in a logical order
- Consistency and standards: check expectations from similar products/interfaces, e.g. categorisation – colour; spatial consistency – layout
- Recognition rather than recall: avoid user need to remember information from one part of the interface to another
- Cater for experienced and inexperienced users; provide choice in how processes are completed
- Aesthetic integrity: keep design simple and focused on essential information.

4.2.5 Change management

An experienced production worker nominated the following series of likely barriers to cobot implementation in the shipyard:

- Fear of the unknown and personal ability to adapt to change
- Fear of increased efficiency and possible loss of jobs
- Insufficient communication of the purpose for the change
- Insufficient stakeholder engagement and adoption of the idea and
- Some being difficult just for the sake of it.

All people-centric aspects, these responses relate to the cornerstones of effective change management, including recognising emotions, sharing information, and regularly communicating with employees and stakeholders. These potential barriers could be mitigated by:

Adoption Accelerator Recommendation 10: A greater understanding of change management principles and adoption of change management models can help to accelerate the successful uptake and diffusion of new technologies. Some frequently adopted models (Ohio University, 2020) include the Kubler-Ross Change Curve (MindTools, n.d.; T. J. Smith, 1994) and the Prosci ADKAR Model (Prosci, n.d.). Important components include:

- Clearly articulate the reasons for change
- Communicate small amounts of information often to avoid employees feeling overwhelmed
- Listen carefully and respond sensitively to employees’ feelings and concerns
- Provide training (both technical, e.g. cobot programming, and personal development, e.g. growth mindset) and allow time for employees to explore and experience the technology without expecting initial high productivity
- Seek ongoing feedback from employees throughout change to identify and address any unforeseen issues early.



It has been said that 70% of change programs fail to achieve their goals, commonly due to employee resistance and lack of management support. Furthermore, when the people involved are committed to the change, it is 30% more likely to be sustained (Ewenstein, Smith, & Sologar, 2015). Therefore, it makes good business sense to invest time and thought into planning and preparing for change (another element to consider within a HFE business case model, see Section 4.2.1).

5 Conclusion and future directions

Users of a cobot for a simple dispensing task responded positively to the technology, although most had a reasonable degree of awareness (although not use) of cobots prior to trial participation. Performance outcomes and usability ratings were associated with design features of the equipment and the laboratory environment, reflecting the dynamic nature of the socio-technical system. Tailoring tools, technology and the environment to fit the purpose and user limitations is an effective way to enhance human performance.

Some of the potential benefits that a cobot can bring a process or business were evaluated here, and partially supported. Namely, minimising musculoskeletal risk and increased productivity. Less clear are the proposed benefits for skill development opportunity, unless carefully considered in approaches to overall job design. Reconfigurability and programming (not evaluated in the current trial), could impact these claims. It is evident that how a cobot is implemented (i.e. technical attributes of the system, type of application/task), the extent of its implementation (i.e. level of collaboration, number of applications involved in) and the sensitivity of the measurement instruments available to evaluate its performance/usability, are key factors that will influence the extent to which any potential benefits are realised and thus influence the extent of user acceptance and job satisfaction.

There is a need among users for greater understanding about how to identify and select tasks/applications that are suitable for cobots, in addition to understanding the hardware and software options available (e.g. software plug-ins, end-effectors, teach pendant, hand-guiding). When developing such a framework or guide, the aforementioned key factors should be incorporated. Researchers, robotics manufacturers and industry can all play a role in increasing the adoption of cobots in Australian businesses by collaborating and sharing their experiences from both a technical and human perspective through case studies and other forms of open access reviews.

In the interim, it will be important for businesses to build, consolidate and refine recruitment processes, training offerings (e.g. identify requisite skills) and change management practices. Clear and relevant communication in a language and medium that is meaningful to the workforce is central to success in each of these activities, as well as including users in the process of designing the adoption process.

While the results of this trial are informative, to increase the reliability of the findings going forward we would look to increase the size and breadth of our sample (the trial involved a relatively small number of participants from a handful of workplaces/types of trade background) and make observations/conduct our evaluation within a real-world/industrial environment. The latter would also allow more opportunities to assess the reconfigurability attribute of cobots.



Appendix A – Pilot study

Pilot studies are an important quality control mechanism to ensure the full-scale study/task/activity is relevant for participants/stakeholders and is feasible. Pilot studies can inform the following:

- Processes – e.g. eligibility criteria, recruitment rate
- Resources – e.g. time to complete, suitable equipment, appropriate and comprehensible evaluation measures
- Management – e.g. data management (difficulties collecting or comparing the data)

Three employees from BAE Systems Maritime Australia's Research and Development team and two employees from Flinders University completed the trial. Based on their feedback the following aspects were refined:

- Process changes
 - Speed that the sealant ('glue') dispensed was faster than anticipated and heightened a feeling of lack of control
 - Improve instructions/ emphasise how to adjust this during practice of manual version of task.
 - Unclear how much glue to dispense (e.g. an expectation that the 1 cm black path should be filled)
 - Improve instructions

From a data management perspective, other improvements were identified by the research team:

- Change setting on cameras so footage occupied less memory
- Reduced paperwork by adding some items to online surveys

Other recommendations that were identified but could not be actioned due to resource restrictions included:

- Increased manoeuvrability around the table (potential limiter of bead quality/precision as not possible to maintain consistent direction). Options considered:
 - Round table – but this was not height adjustable
 - Turning rectangular desk on its end – solid leg of table would interfere/potential trip hazard/require leaning/awkward posture where feet are not directly underneath you.

Appendix B – Statistical analysis

Parametric statistics assume that the measure being analysed has a normal distribution where most of the data points fall around the middle/mean value and less data points fall at more extreme values/ further away from the mean. A normal distribution is symmetrical and resembles a bell shape. The distribution of data can be assessed through a test for normality; a significant Shapiro-Wilk test (more appropriate for sample sizes less than 50¹⁵) indicates that the data are not normally distributed and the assumption has been violated. Often in this instance, utilising non-parametric statistics is advisable.

The parametric statistic used to compare performance of the same individual between two conditions (e.g. manual and cobot-assisted dispensing) was a paired samples t-test. However, sample size influences the distribution of data as smaller sample sizes are more likely to produce data with non-normal distributions, thus violating the assumption of normality. When this occurs, as was the case for the current data, non-parametric statistics are employed.

Non-parametric alternatives to a paired samples t-test are the Paired Sample Wilcoxon test (Wilcoxon Signed-Rank Test) or the sign test. Each of these tests also has several assumptions about the characteristics of the data, summarised in Table 8 below. Sign tests were conducted for the trial data due to better alignment with the assumptions.

Table 8: Assumptions of non-parametric alternatives to the paired samples t-test

Wilcoxon Signed-Rank Test	Sign Test
The dependent variable (i.e. performance measure) should be measured at the ordinal (e.g. rating scale) or continuous level (linear scale like seconds, height)	The dependent variable (i.e. performance measure) should be measured at the ordinal (e.g. rating scale) or continuous level (linear scale like seconds, height)
The independent variable (i.e. dispensing method) should have two categorical related groups or matched pairs (i.e. same person present in each condition)	The independent variable (i.e. dispensing method) should have two categorical related groups or matched pairs (i.e. same person present in each condition)
The distribution of the difference between the performance scores of each dispensing method needs to be symmetrical in shape	The paired observations for each case/participant need to be independent, i.e. one participant's data cannot influence another participant's data
	The difference scores are from a continuous distribution (i.e. data can take any value within a specified range, such as non-integers/decimal values)

Source: Adapted from Laerd Statistics (<https://statistics.laerd.com/spss-tutorials/sign-test-using-spss-statistics.php>)

The sign test assesses whether the median of the difference between scores on a measure is zero. A significant result indicates the median difference is not equal to zero and there has been an increase or decrease in the median score.

Effect size

Cohen's *d* is an appropriate measure of effect size for the comparison between two means and can be used to complement reporting of t-test and ANOVA results. It is also commonly reported in meta-analyses (McLeod, 2019). It redefines the difference in means as the number of standard deviations that separate those means (Data Novia, n.d.), and for this repeated measures design is represented by:

¹⁵ See <https://statistics.laerd.com/spss-tutorials/testing-for-normality-using-spss-statistics.php>



$$d = \frac{[\text{mean of manual measurement (M}_m)] - [\text{mean of cobot measurement (M}_c)]}{\text{Combined Standard Deviation (SD)}}$$

In the absence of any interpretation guidelines available at the time, Cohen (1988) proposed the following benchmarks as a framework: 0.2 = small effect, 0.5 = medium effect and 0.8 = large effect. A d of 1 indicates the means differ by 1 SD. When $d=0.2$, the difference between the two means is less than 0.2 SDs and is considered negligible (even if statistically significant) (McLeod, 2019). However, Cohen's d can be sensitive to sample size and is most appropriate (reliable) for sample sizes of 50 or more. For sample sizes smaller than this, it is likely the effect size will be over-inflated. To offset this distortion, the following correction can be used and was applied here:

$$d = \frac{m_A - m_B}{SD_{pooled}} \times \left(\frac{N - 3}{N - 2.25} \right) \times \sqrt{\frac{N - 2}{N}}$$

Source: Data Nova (n.d.); (Statistics How To, n.d.)

It is critical to take into account the nature and context of the measures being assessed when ultimately interpreting the effect size. For example, in some instances, small effect sizes can have a large impact (e.g. academic scores) (Statistics How To, n.d.). Ideally, effect sizes should be interpreted alongside those from studies with similar characteristics (i.e. design, types measures/variables, sample size) and be described in terms such as 'typical' or 'comparable' (Bakker et al., 2019).

Currently, there is a lack of comparative studies relevant to the findings presented here. The closest approximate comparison found to date relates to a study by Pollak, Paliga, Pulpulos, Kozusznik, and Kozusznik (2020) who applied a repeated measures design to evaluate stress levels when operating cobots in manual (each step in the human-cobot collaboration is initiated by the human) and autonomous (cobot controls all the operations by itself) modes ($n=45$ adults). For those who carried out an autonomous task first, the level of primary stress appraisal (a two-item, self-report measure) was significantly lower (i.e. less stressful/challenging) in the manual mode than in the autonomous mode ($d=0.45$). When the task was first completed in the manual mode, there was no statistically significant difference in mean.

Appendix C – Individual glue-bead performance analysis

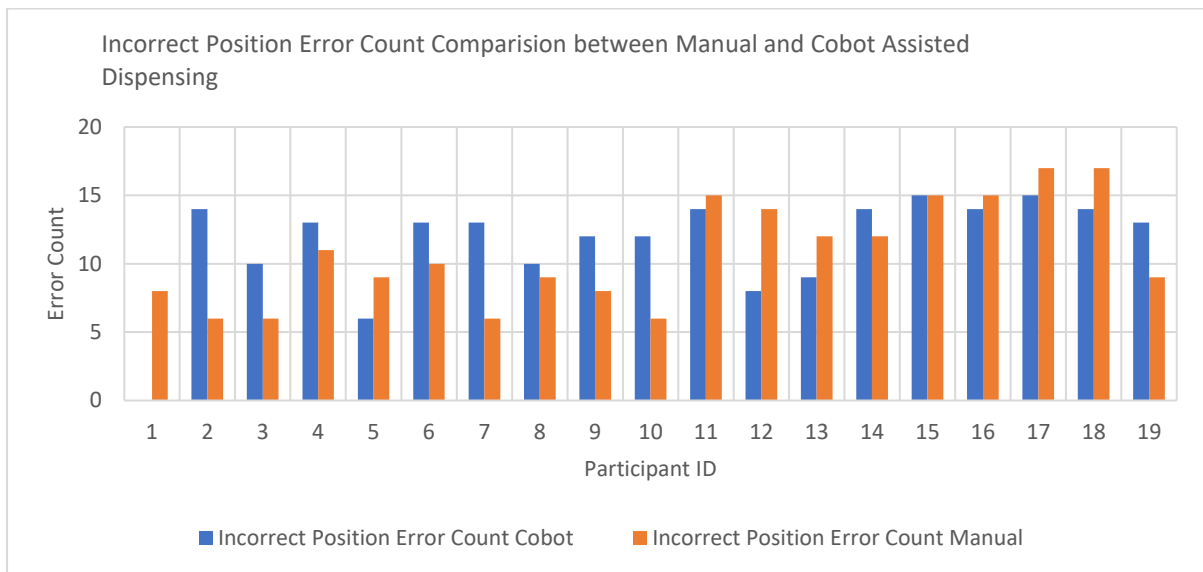
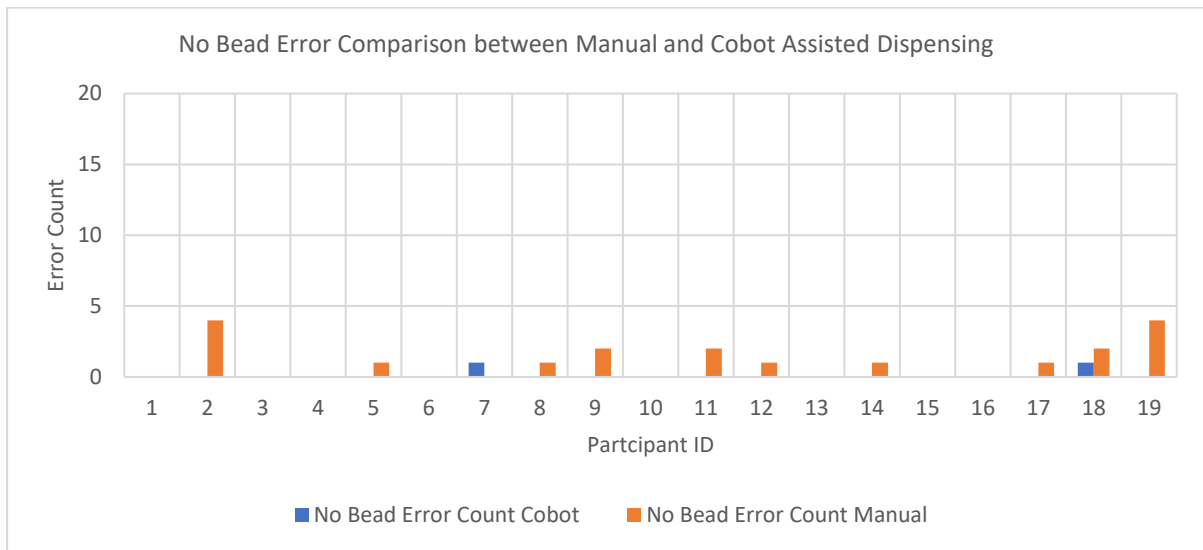

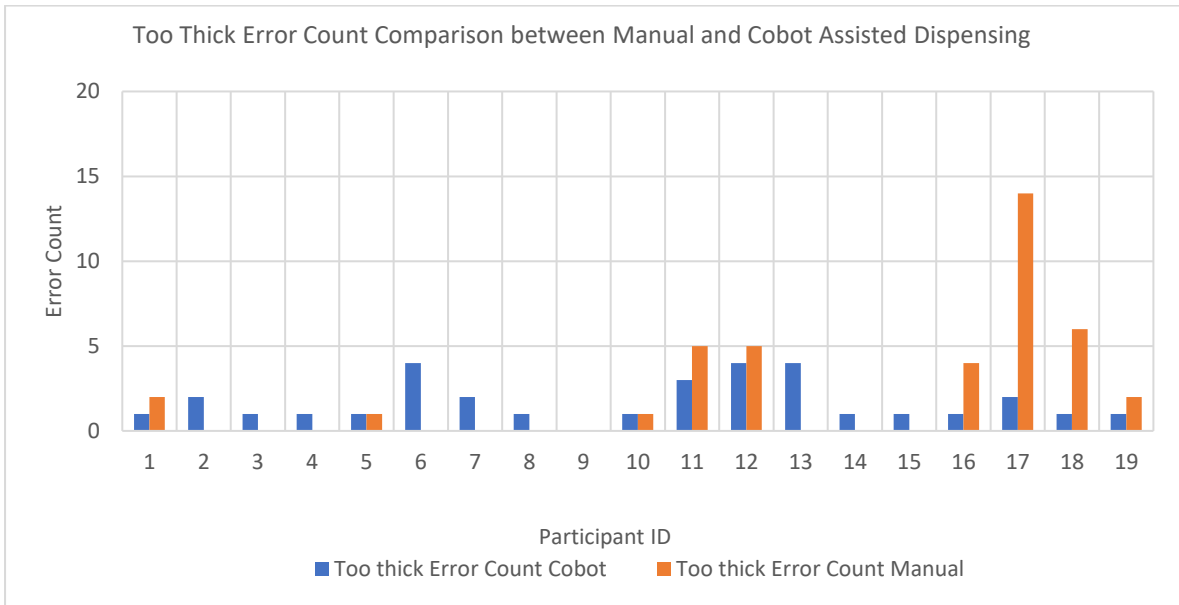
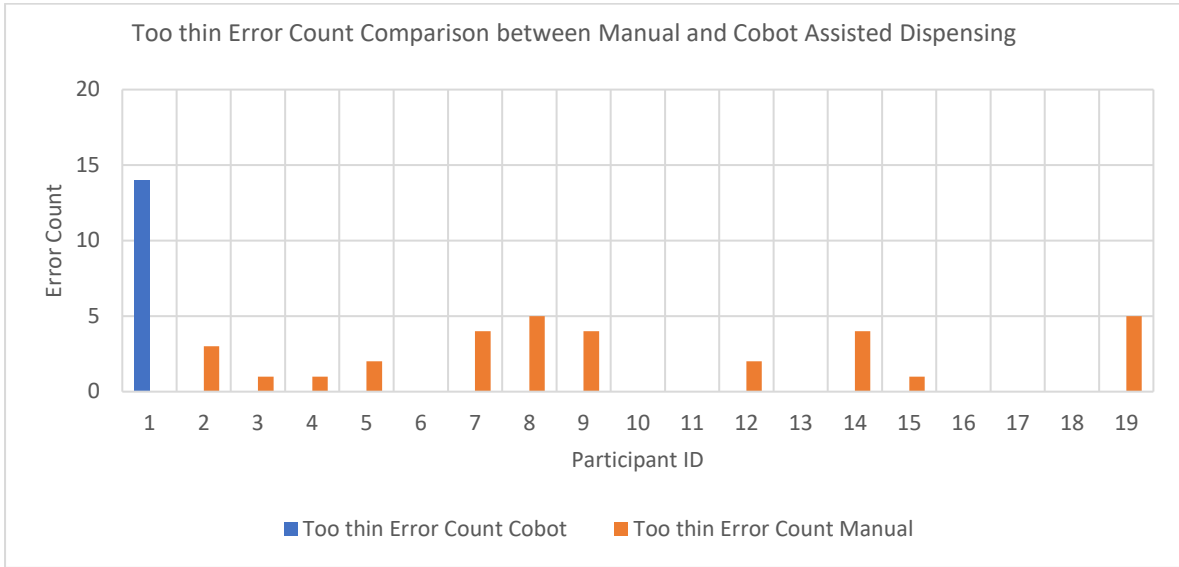

References

- Aaltonen, I., & Salmi, T. (2019). Experiences and expectations of collaborative robots in industry and academia: barriers and development needs. *Procedia Manufacturing*, 38, 1151-1158.
- AI Group. (2019). *Australian Manufacturing in 2019 Local and Global Opportunities*. Retrieved from https://cdn.aigroup.com.au/Economic_Indicators/Economic_Outlook/Australian_Manufacturing_in_2019.pdf
- Altman, D. G., & Bland, J. M. (2005). Standard deviations and standard errors. *British Medical Journal*, 331, 903.
- AMFG. (2019). Industry 4.0: Real-world examples of digital manufacturing in action. Retrieved from <https://amfg.ai/2019/03/28/industry-4-0-7-real-world-examples-of-digital-manufacturing-in-action/>
- Annett, J. (2004). Hierarchical task analysis (HTA). In N. Stanton, A. Hedge, K. Brookhuis, E. Salas, & H. Hendrick (Eds.), *Handbook of Human Factors and Ergonomics Methods* (pp. 329-337). Florida: CRC Press.
- AtlasCopco. (2019). *Pocket Guide on Adhesive Bonding*. Retrieved from <https://www.atlascopco.com/content/dam/atlas-copco/industrial-technique/general/documents/pocketguides/AC-Pocket-Guide-Adhesive-Bonding-EN-web.pdf>
- Australian Bureau of Statistics. (2012). 4338.0 Profiles of Health, Australia, 2011-13. Retrieved from <https://www.abs.gov.au/ausstats/abs@.nsf/Lookup/4338.0main+features212011-13>
- Bakker, A., Cai, J., English, L., Kaiser, G., Mesa, V., & Van Dooren, W. (2019). Beyond small, medium, or large: points of consideration when interpreting effect sizes. *Educational Studies in Mathematics*, 102, 1-8.
- Bauer, W., Bender, M., Braun, M., Rally, P., & Scholtz, O. (2016). *Lightweight robots in manual assembly - best to start simply! Examining companies' initial experiences with lightweight robots*. Retrieved from Stuttgart:
- Bernard, F., Zare, M., Sagot, J.-C., & Paquin, R. (2020). Using digital and physical simulation to focus on human factors and ergonomics in aviation maintainability. *Human Factors*, 62(1), 37-54.
- Bloss, R. (2016). Collaborative robots are rapidly providing major improvements in productivity, safety, programming ease, portability and cost while addressing many new applications. *Industrial Robot: An International Journal*, 463-468.
- BMW Group. (2013). Innovative human-robot cooperation in BMW Group Production. Retrieved from <https://www.press.bmwgroup.com/global/article/detail/T0209722EN/innovative-human-robot-cooperation-in-bmw-group-production?language=en>
- Burnes, B. (2012). Field Theory of Learning. In N. M. Seel (Ed.), *Encyclopedia of the Sciences of Learning*. Boston: Springer.
- Cadete, L. (2017). What is a pilot study? *Tutorials and Fundamentals*. Retrieved from <https://s4be.cochrane.org/blog/2017/07/31/pilot-studies/>
- Campbell, J. (2019). Cobots improve productivity, shifting workers away from dirty, dangerous, and dull jobs. Retrieved from <https://www.isa.org/intech-home/2019/november-december/features/cobots-and-workers-better-together>
- CEBR. (2017). *The impact of automation*. Retrieved from
- Center for Occupational and Environmental Health (COEH). (n.d.). What is anthropometry? Data driven design. Retrieved from <https://www.coeh.berkeley.edu/post/what-is-anthropometry>
- Cohen, J. (1988). *Statistical power analysis for the behavioural sciences*. Hillsdale, NJ: Erlbaum.
- Colgate, J. E., & Peshkin, M. A. (1999). USA Patent No. US5952796A.
- Colim, A., Carnerio, P., Costa, N., Faria, C., Rocha, L., Sousa, N., . . . Arezes, P. M. (2020). Human-centred approach for the design of a collaborative robotics workstation. In P. M. Arezes, J. S. Baptista, M. P. Barroso, P. Carneiro, P. Corderio, N. Costa, & R. B. Melo (Eds.), *Occupational and Environmental Safety and Health II* (pp. 379-387). Switzerland: Springer.
- Cresswell, K. M., Blanford, A., & Sheikh, A. (2017). Drawing on human factors engineering to evaluate the effectiveness of health information technology. *Journal of the Royal Society of Medicine*, 110(8), 309-315.
- CSIRO. (2016). *Advanced Manufacturing. A roadmap for unlocking future growth opportunities for Australia*. Retrieved from Melbourne:



- Data Novia. (n.d.). T-test effect size using Cohen's d measure. Retrieved from [https://www.datanovia.com/en/lessons/t-test-effect-size-using-cohens-d-measure/#:~:text=To%20calculate%20an%20effect%20size,%20%3D%20sd\(x\)%20.&text=%CE%BC%20is%20the%20theoretical%20mean,value%20is%20mu%20%3D%200](https://www.datanovia.com/en/lessons/t-test-effect-size-using-cohens-d-measure/#:~:text=To%20calculate%20an%20effect%20size,%20%3D%20sd(x)%20.&text=%CE%BC%20is%20the%20theoretical%20mean,value%20is%20mu%20%3D%200).
- Davis, F. D., Bagozzi, R. P., & Warshaw, P. R. (1989). User acceptance of computer technology: a comparison of two theoretical models. *Management Science*, 35(8), 982-1003.
- Deloitte. (2019). *Automated growth: the economic impacts of industrial robots in Australia*. Retrieved from Adelaide, SA:
- DOIG Corp. (2021). OB7 CNC Machine Tending Cobot. Retrieved from <https://www.doigcorp.com/Home/OB7-CNC-Machine-Tending-Cobot/>
- Drogemuller, M. (2019, February) *Site Visit to Penfolds Barossa Valley Treasury Wines Nuriootpa, South Australia/Interviewer: K. Manning*.
- Engineering 360. (2020). Cobots improve efficiency and reduce floorspace for electronics provider. Retrieved from <https://insights.globalspec.com/article/14331/cobots-improve-efficiency-and-reduce-floorspace-for-electronics-provider#:~:text=With%20cobots%2C%20the%20company%20is,manufacturing%20space%20has%20been%20saved>.
- Ewenstein, B., Smith, W., & Sologar, A. (2015). Changing change management. Retrieved from <https://www.mckinsey.com/featured-insights/leadership/changing-change-management>
- Farkas, P. (2020). Why use collaborative robots over conventional industrial robots? Retrieved from <https://aubo-robotics.com/2020/07/20/why-use-collaborative-robots-over-conventional-industrial-robots/>
- Fiske, D. W., & Fiske, S. T. (2005). Laboratory Studies. In K. Kempf-Leonard (Ed.), *Encyclopedia of Social Measurement, Volume 2*. Cambridge, Massachusetts: Elsevier Academic Press.
- Gotfredsen, S. (2017a). Calculating ROI and payback period for your robotic investment. Retrieved from <https://www.universal-robots.com/blog/calculating-roi-and-payback-period-for-your-robotic-investment/>
- Gotfredsen, S. (2017b). Case-study: Cobots in Food and Beverage Manufacturing. Retrieved from <https://apfoodonline.com/industry/case-study-cobots-in-fb-manufacturing/>
- Graco. (2021). PRECISION DISPENSE FOR BONDING AND SEALING. Retrieved from <https://www.graco.com/us/en/in-plant-manufacturing/solutions/articles/precision-dispense-for-bonding-and-sealing.html>
- Greene, J. C., Caracelli, V. J., & Graham, W. F. (1989). Toward a conceptual framework for mixed-method evaluation designs. *Educational Evaluation and Policy Analysis*, 11, 255-274.
- Grier, R. (2015). *How high is high? A meta-analysis of NASA-TLX global workload scores*. Paper presented at the Proceedings of the Human Factors and Ergonomics Society Annual Meeting.
- Hackman, J. R., & Oldham, G. R. (1976). Motivation through the Design of Work: Test of a Theory. *Organizational Behavior and Human Performance*, 16, 250-279.
- Hart, S. G. (2006). *NASA-Task Load Index (NASA-TLX); 20 years later*. Paper presented at the Proceedings of the Human Factors and Ergonomics Society 50th Annual Meeting, Santa Monica.
- Hart, S. G., & Staveland, L. E. (1988). Development of NASA-TLX (Task Load Index): Results of empirical and theoretical research. In *Advances in psychology* (Vol. 52, pp. 139-183): Elsevier.
- ISO. (2011a). ISO 10218-1:2011 Robots and robotic devices — Safety requirements for industrial robots — Part 1: Robots. In. Geneva, Switzerland: ISO.
- ISO. (2011b). ISO 10218-2:2011 Robots and robotic devices — Safety requirements for industrial robots — Part 2: Robot systems and integration. In. Geneva, Switzerland: ISO.
- Kantarci, A. (2021). Collaborative Robots (Cobots): Indpeth Guide 2021. Retrieved from <https://research.aimultiple.com/cobot/>
- Kildal, J., Tellaeché, A., Fernandez, I., & Maurtua, I. (2018). Potential users' key concerns and expectations for the adoption of cobots. *Procedia CIRP*, 72, 21-26.
- Kittel, A. (2019) *REDARC celebrates 40 years of manufacturing - Interview with Owner and Managing Director of REDARC/Interviewer: R. Electronics*.
- Knight, J. (2015). The most common mistake people make in calculating ROI. Retrieved from <https://hbr.org/2015/04/the-most-common-mistake-people-make-in-calculating-roi>
- KUKA. (2016). Many wrenches make light work: KUKA flexFELLOW will provide assistance during drive train pre-assembly. Retrieved from <https://www.kuka.com/en-gb/press/news/2016/10/20160926vwsetztaufmensch-roboter-kollaboration>

- Leonard-Barton, D. (1988). Implementation characteristics of organisational innovations: limits and opportunities for management strategies. *Communication Research* 15(1), 603-631.
- Manning, K., Jang, R., Rajagopalan, A., Yaron, P., Spoehr, J., Hordacre, A.-L., & Moretti, C. (2021). *Robotics and the digital shipyard*. Retrieved from Adelaide: Manufacturers' Monthly. (2020). Introducing cobots into the workplace: here's what you need to know. Retrieved from <https://www.manmonthly.com.au/features/introducing-cobots-workplace-heres-need-know/>
- Martin, C. (2020, March 4th 2020) *RAETIG Site Visit (March 2020) at Electrolux Dudley Park, South Australia/Interviewer: C. Thomas*.
- McAtamney, L., & Corlett, E. N. (1993). RULA: A survey method for the investigation of work-related upper limb disorders. *Applied Ergonomics*, 24(2), 91-99.
- McLeod, S. (2019). What does effect size tell you? Retrieved from <https://www.simplypsychology.org/effect-size.html>
- Middlesworth, M. (n.d.). A step-by-step guide to the RULA Assessment Tool. Retrieved from <https://ergo-plus.com/rula-assessment-tool-guide/>
- MindTools. (n.d.). The change curve. Accelerating change, and increasing its likelihood of success. Retrieved from https://www.mindtools.com/pages/article/newPPM_96.htm
- Mobile Automation. (n.d.). What industries can use cobots? Retrieved from <https://www.mobileautomation.com.au/industries-using-cobots/#:~:text=Although%20the%20average%20cost%20of,typically%20of%20just%206%20months!&text=Flexible%20Deployment%20is%20crucial%20in,must%20be%20versatile%20and%20flexible.>
- MultiPix imaging. (2021). Bead Inspection improved in HALCON 12. Retrieved from <https://multipix.com/supportblog/bead-inspection/>
- MVtec Software GmbH. (2016). Bead Inspection. *HALCON Operator Reference* Retrieved from https://www.mvtec.com/doc/halcon/12/en/apply_bead_inspection_model.html#ErrorType
- National Library of Medicine. (n.d.). Finding and using health statistics. Standard deviation. Retrieved from [https://www.nlm.nih.gov/nichsr/stats_tutorial/section2/mod8_sd.html#:~:text=A%20standard%20deviation%20\(or%20CF%83,data%20are%20more%20spread%20out.](https://www.nlm.nih.gov/nichsr/stats_tutorial/section2/mod8_sd.html#:~:text=A%20standard%20deviation%20(or%20CF%83,data%20are%20more%20spread%20out.)
- NeoMetrix Technologies Inc. (2017). Creaform HandyScan R - Robotic 3D Scanning. Retrieved from <https://www.youtube.com/watch?v=ODHZ2Kh2b0k>
- Nielsen, J. (2020). 10 Usability heuristics for user interface design. Retrieved from <https://www.nngroup.com/articles/ten-usability-heuristics/>
- O'Keeffe, V., Moretti, C., Hordacre, A.-L., Howard, S., & Spoehr, J. (2020). *Quicker off the blocks: The role of human factors in the uptake and diffusion of advanced technologies in shipbuilding*. Retrieved from Adelaide:
- Oakman, J., Clune, S., & Stuckey, R. (2019). *Work-related musculoskeletal disorders in Australia, 2019*. Retrieved from Canberra:
- Ohio University. (2020). Five change management models in business. Retrieved from <https://onlinemasters.ohio.edu/blog/five-change-management-models-in-business/>
- Onwuegbuzie, A. J., & Leech, N. L. (2005). On becoming a pragmatic researcher: The importance of combining quantitative and qualitative research methodologies. *International Journal of Social Research Methodology*, 8(5), 375-387.
- Papadatou-Pastou, M., Ntolka, E., Schmitz, J., Martin, M., Munafo, M. R., Ocklenburg, S., & Paracchini, S. (2020). Human handedness: A meta-analysis. *Psychological Bulletin*, 146(6), 481-524.
- Pittman, K. (2021). Infographic: A Brief History of Collaborative Robots. Retrieved from <https://www.engineering.com/story/infographic-a-brief-history-of-collaborative-robots>
- Pollak, A., Paliga, M., Pulopulos, M. M., Kozusznik, B., & Kozusznik, M. W. (2020). Stress in manual and autonomous modes of collaboration with a cobot. *Computers in Human Behavior*, 112(106469).
- Prosci. (n.d.). The Prosci ADKAR Model. A simple but powerful model for driving successful change in individuals and organisations. Retrieved from <https://www.prosci.com/adkar>
- Ratini, M. (2019). Average heights of men around the world. Retrieved from https://www.medicinenet.com/height_men/article.htm
- Robotics and Automation News. (2017). Innovative Skoda factory introduces human-robot collaboration with KUKA LBR iiwa. Retrieved from <https://roboticsandautomationnews.com/2017/02/16/innovative-skoda-factory-introduces-human-robot-collaboration-with-kuka-lbr-iiwa/11404/>



- RT Robotics AB YouTube Channel. (2020). DOOSAN M1013 - UniGripper Co/Light Vacuum gripper - Palletizing robot handles a whole EU pallet. Retrieved from <https://www.youtube.com/watch?v=3wH-IgAwYUY>
- Smith, R. (2018). South Korea has the highest density of robot workers in the world. Retrieved from <https://www.weforum.org/agenda/2018/04/countries-with-most-robot-workers-per-human/>
- Smith, T. J. (1994). Core principles of human factors science. *Proceedings of the Human Factors and Ergonomics Society 38th Annual Meeting*, 38(9), 536-540.
- Sonmez, V., Testik, M. C., & Testik, O. M. (2018). Overall equipment effectiveness when production speeds and stoppage durations are uncertain. *International Journal of Advanced Manufacturing Technology*, 95, 121-130.
- Spectrum IEEE. (2021). Boston Dynamics' Spot robot gets an arm. Retrieved from <https://spectrum.ieee.org/automaton/robotics/industrial-robots/boston-dynamics-spot-robot-arm>
- Statistics How To. (n.d.). Cohen's D: Definition, Examples, Formulas. Retrieved from <https://www.statisticshowto.com/cohens-d/>
- Techman Robot YouTube Channel. (2019). V2A019 TM Robot - SMT Pick & Place Process. Retrieved from https://www.youtube.com/watch?v=1e_bY-CBwOY
- The Robot Report YouTube Channel. (2019). Robotiq Sanding Kit for Universal Robots. Retrieved from <https://www.youtube.com/watch?v=gsQevFE23G0>
- Tillman, B., Fitts, D. J., Woodson, W. E., Rose-Sundholm, R., & Tillman, P. (2016). *Human factors and ergonomics design handbook*: McGraw-Hill Education.
- Universal Robots. (2018). UR10 cobots offer aging workforce solution and reduce relief worker costs for global car manufacturer. Retrieved from <https://www.universal-robots.com/case-stories/nissan-motor-company/>
- Universal Robots. (n.d.). Case studies. Retrieved from <https://www.universal-robots.com/case-stories/>
- van Teijlingen, E., & Hundley, V. (2001). The importance of pilot studies. *Social research UPDATE*.
- Vido, M., Scur, G., Massote, A. A., & Lima, F. (2020). The impact of the collaborative robot on competitive priorities: case study of an automotive supplier. *Gestão & Produção*, 27(4), e5358.
- Von Hollen, J. (2019). How cobots are levelling the manufacturing playing field. Retrieved from <https://www.universal-robots.com/blog/how-cobots-are-levelling-the-manufacturing-playing-field/>
- Vysocky, A., & Novak, P. (2016). Human-Robot collaboration in industry. *MM Science Journal*, 9(2), 903-906.
- Wang, C.-Y., & Cai, D.-C. (2017). *Hand tool handle design based on hand measurements*. Paper presented at the MATEC Web of Conferences.
- Wang, L., Gao, R., Vancza, J., Kruger, J., Wang, X. V., Makris, S., & Chryssolouris, G. (2019). Symbiotic human-robot collaborative assembly. *CIRP Annals - Manufacturing Technology*, 68, 701-726.
- Weber, A. (2019). Minimizing waste in the dispensing process. Automation can help cut costs and improve operating efficiency. Retrieved from <https://www.assemblymag.com/articles/94624-minimizing-waste-in-the-dispensing-process>
- Winkelmann, N. (2017). Human-Robot Cooperation at Audi. Retrieved from <https://www.springerprofessional.de/en/manufacturing/production---production-technology/human-robot-cooperation-at-audi/14221870>
- Workplace Gender Equality Agency. (2019). Gender segregation in Australia's workforce. Retrieved from <https://www.wgea.gov.au/publications/gender-segregation-in-australias-workforce>
- Zanchettin, A. M., Croft, E., Ding, H., & Li, M. (2018). Collaborative robots in the workplace [from the guest editors]. *IEEE Robotics & Automation Magazine*, 25(2), 16-17.



Australian Industrial Transformation Institute
College of Business, Government and Law
Flinders University
GPO Box 2100
Adelaide SA 5001
P: 08 8201 5083
E: aiti@flinders.edu.au

